

VICI Jour[®]

Chromatography
Fluid/Gas Transfer



CONTENTS



2	New from VICI Jour
8	Tubing
22	Fittings introduction
24	High pressure polymeric fittings
36	Ultra high pressure stainless fittings
42	High pressure Nanovolume® HPLC fittings
46	Low pressure polymeric fittings
56	Filters
66	Safety products
86	Frits
90	Columns
94	Sample loops
98	Accessories
106	General reference
122	Index by product number
124	Index by product name
126	Ordering information

VICI AG INTERNATIONAL

Europe, Middle East, Asia, Africa

SALES	ADDRESS
PHONE Int + 41- 41- 925-6200	Parkstrasse 2 CH-6214 Schenkon Switzerland
EMAIL order@vici.ch	info@vici.ch
TECHNICAL	SERVICE
PHONE Int + 41- 41- 925-6200	Int + 41- 41- 925-6200
EMAIL support@vici.ch	support@vici.ch

VICI PRECISION SAMPLING

United States, Mexico, Central America, South America, Australia, New Zealand

CONTACT	ADDRESS
PHONE 225-927-1128 800-828-1653	P.O. Box 15886 Baton Rouge, LA 70895 USA
FAX 225-923-1331	
EMAIL precision@vici.com	

VICI VALCO INSTRUMENTS CANADA

Canada

SALES	ADDRESS
PHONE 613-342-2600 866-297-2626	26 Water Street East Brockville, Ontario Canada K6V 1A1
FAX 613-342-0111	
EMAIL canada@vici.com	

i CERTIFICATIONS



VICI AG INTERNATIONAL

VICI Jour has been a part of VICI AG International in Switzerland since 2004. The complete Jour line of accessories and consumables for fluid transfer in GC and LC is available from VICI AG International, VICI Valco Canada, VICI Precision Sampling, and through our international distributor network.

VICI AG International, in Schenkon, Switzerland, is an independent site for the manufacturing of Valco and Cheminert valves and the handling of all VICI product lines in Europe, Africa, the Middle East, and the Far East.

VICI AG International has obtained the ISO certificate to the standard of 9001:2008, and is the first ISO-certified manufacturer of high pressure and low pressure valves for scientific equipment.

VICI JOUR PRODUCT LINE

Jour products include a complete line of tubing and capillaries in a wide variety of diameters and materials, high and low pressure fingertight fittings and connection accessories, column hardware, high and low pressure filters, cutters and other tools, backpressure regulators, and much more.

We offer accessories and consumables for fluid transfer in GC and LC, including:

- Fittings - high pressure polymeric and stainless, Nanovolume® PEEK and stainless, and low pressure
- Tubing and sample loops
- Safety products and mobile phase handling systems
- Filters and frits
- PEEK columns and guard columns

i CERTIFICATION

Please note:
All Jour pieces are not according to TSE-BSE regulations.



NEW FROM VICI JOUR

TUBING

VICI offers new FS tubing, new SS Precut tubing for Micro LC, new tubing packaging sizes, and new tubing dimensions.

NEW Untreated fused silica (FS) capillaries

PAGE 18

Our NEW FS capillaries are manufactured from fused silica coated with a layer of polyimide to make them more flexible and robust. These chemically inert capillaries, stable at temperatures up to 350°C, are suitable for Micro and Nano LC applications involving organic solvents and other fluids in pH ranges from 0 to 10.

Sold by the meter.

OD	ID	per meter Product No.
360 µm	25 µm	JR-T-7360-025
	50 µm	JR-T-7360-050
	75 µm	JR-T-7360-075
	100 µm	JR-T-7360-100
	150 µm	JR-T-7360-150
	180 µm	JR-T-7360-180



NEW Polymeric tubing – new sizes

PAGES 9-13, 15-16

For our full lines of PEEK, ETFE, PFA, FEP, and PTFE tubing, see pages noted above.

	OD	ID (mm)	1.5 m Product No.	3 m Product No.	10 m Product No.	15 m Product No.	25 m Product No.
PEEK	1/32"	0.15	JR-T-5706-M1.5	JR-T-5706-M3	JR-T-5706-M10	—	—
ETFE	1/8"	2.40	JR-T-089-M1.5	JR-T-089-M3	JR-T-089-M10	JR-T-089-M15	JR-T-089-M25
	6.4 mm	4.8	—	JR-T-090-M3	—	—	—

	OD	ID (mm)	per meter Product No.
PEEK	1/16"	0.064	JR-T-5998-0005
PFA	1/4"	3.97	JR-T-4006
		4.80	JR-T-4008
FEP, natural	4 mm	3.00	JR-T-6860
	1/4"	3.96	JR-T-6840
		3/16"	JR-T-6841
	5/16"	1/4"	JR-T-6650
PTFE, natural	1/8"	1.00 mm	JR-T-6820
	6.00 mm	4.00 mm	JR-T-4042
	6.35 mm	4.76 mm	JR-T-6810
	8.00 mm	6.00 mm	JR-T-4050
	12.7 mm	9.53 mm	JR-T-4043





STAINLESS STEEL TUBING

VICI is now able to offer smaller diameters in 360 micron, 1/32", and 1/16" OD stainless tubing.

NEW Stainless tubing – standard grade UHPLC PAGE 19

OD	ID (mm)	1.5 m	3 m	10 m
		Product No.	Product No.	Product No.
1/16"	0.10	JR-T-625-03-M1.5	JR-T-625-03-M3	JR-T-625-03-M10

NEW Stainless tubing – premium grade UHPLC PAGE 19

For Micro and Nano LC

OD	ID (µm)	per meter
		Product No.
360 µm	75	JR-T-623-03
	150	JR-T-623-06



NEW Pre-cut tubing for Micro LC PAGE 20

1/32" OD tubing with IDs of 50 and 75 micron is only offered in pre-cut lengths. Each pre-cut piece is electrolytically cut and steam cleaned, ready for use in any (U)HPLC System.

OD	ID (mm)	Color	50 mm	100 mm	130 mm
			Product No.	Product No.	Product No.
1/32"	0.050	Blue	JR-T-91050	JR-T-91100	JR-T-91130
	0.075	Black	JR-T-92050	JR-T-92100	JR-T-92130

OD	ID (mm)	Color	180 mm	200 mm	300 mm
			Product No.	Product No.	Product No.
1/32"	0.050	Blue	JR-T-91180	JR-T-91200	JR-T-91300
	0.075	Black	JR-T-92180	JR-T-92200	JR-T-92300

NEW Pre-cut tubing for standard HPLC PAGE 21

VICI added SS pre-cut lengths of 130 mm and 180 mm for 1/16" OD tubing and for pre-cut flexible stainless steel tubing. Lengths of 130 mm and 180 mm are commonly used for (U)HPLC systems.

OD	ID (mm)	Color	130 mm	180 mm
			Product No.	Product No.
1/16"	0.13	Red	JR-T-97012	JR-T-97013
	0.18	Yellow	JR-T-97032	JR-T-97033
	0.25	Blue	JR-T-97057	JR-T-97058
	0.50	Orange	JR-T-97082	JR-T-97083
	0.75	Green	JR-T-97102	JR-T-97103





FITTINGS

NEW PEEK one-piece fingertight fittings 10-32

PAGE 26

- Reinforced glass fiber (GF) PEEK.
- Fingertight up to 350 bar (5000 psi)
- One-piece – no ferrule required
- Biocompatible

Sold in packages of 5.

(Package/5)		Material			Product No.
	Standard	Reinforced GF PEEK	 9.15 mm	 20.8 mm	JR-5513-5
	Narrow hexhead/ fingertight	Reinforced GF PEEK	 1/4"	 28.1 mm	JR-5518-5

NEW High pressure PEEK-HT™ one-piece fittings

PAGE 27

VICI fittings made from PEEK™ HT are rated up to 500 bar as fingertights and up to 1000 bar when tightened with a tool. The superior material also provides the benefit of longer life time; that is, the fittings can be tightened/ loosened more often.



Sold in packages of 5.





(Package/5)	Product No.
	JR-55031-5

NEW Medium pressure PVDF one-piece fingertight fittings

PAGE 26

VICI fingertight fittings made from PVDF are rated up to 180 bar. They are applicable up to medium pressures; using polymeric tubing they prevent constriction of tubing as with PEEK fingertight fittings.

Sold in packages of 5.

(Package/5)	PVDF	Translucent white	JR-55020-PVDF-5
			

NEW Low pressure polypropylene adapters

PAGE 54

VICI offers two additional low pressure PP adapters with 1/4-28 bottom sealing thread, to male Luer lock and to barbed 1/16".

	Inlet		Outlet		Product No.
(Sold individually)	Male	1/4-28 UNF BST	Barbed	1/16"	JR-075012
(Package/10)	Male	Luer	Male	1/4-28 UNF BST	JR-070226-10

FILTERS

HIGH PRESSURE

High pressure precolumn and inline filters now include 0.2 micron filter elements. These filters prevent any damage to chromatographic columns, enabling safe, robust chromatographic separations.

NEW Stainless steel precolumn filter MICRO LC PAGE 64

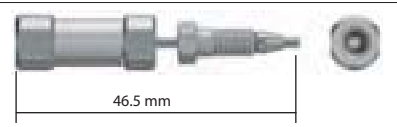
Bore size	Pore size	Internal volume	Product No.	
0.13/0.15 mm	0.2 μm	0.66 μL	JR-69230-02	

NEW Stainless steel in-line filter MICRO LC PAGE 65

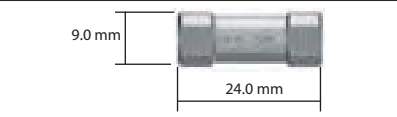
Bore size	Pore size	Internal volume	Product No.	
0.25 mm	0.2 μm	0.3 μL	JR-68230-02	

LOW PRESSURE

For low pressure, a newly designed all-stainless mobile phase filter comes with a stainless stepped connector for direct coupling to mobile phase tubing. The filter is available in three different porosities – 2, 10, and 20 micron.

NEW Stainless steel mobile phase filter/helium sparger LOW PRESSURE PAGE 61

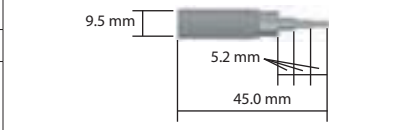
Fitting type	Tubing ID/ pipe size	Pore size	Product No.	
Stepped	1/16", 3/32", and 3.76 mm	2 μm	JR-8000-0495-2	
		10 μm	JR-8000-0495-10	
		20 μm	JR-8000-0495-20	

SAFETY

Safety exhaust filters with **NEW** breakthrough detectors **PAGES 68-69**



Exhaust filter with **NEW** detector

VICI offers exhaust filters with new breakthrough detectors. The newly-designed total organic vapor (TOV) breakthrough detector allows additional detection of aliphatic hydrocarbons (i.e. hexane) and aromatic hydrocarbons (i.e. benzene).



NEW Replacement exhaust filter kits **PAGE 68**

Includes three exhaust filters, three breakthrough detectors (if ordered), and a carrying case.

Description	Product No.
Exhaust filter kit	JR-S-35

Kit includes:	Qty	Product No.
Exhaust filters with breakthrough detectors	3	JR-S-20005
Carrying case	1	JR-S-35L

Description	Product No.
Exhaust filter kit without detectors	JR-S-36

Kit includes:	Qty	Product No.
Exhaust filters without breakthrough detectors	3	JR-S-20002
Carrying case	1	JR-S-35L

VICI CAP KITS **PAGE 74**

HPLC systems use up to four different mobile phases. We offer two safety cap kits for use with gradient (up to quaternary) HPLC systems.

NEW VICI cap kit **GL45 THREADS**



Description	Product No.
VICI cap kit	JR-S-31

Kit includes:	Qty	Product No.
VICI caps, GL45, three ports	4	JR-S-11002
Air inlet valves with 4 mm filters	4	JR-S-20003
PP plugs	4	JR-201999
Carrying case	1	JR-S-31

NEW VICI cap kit **GL45 THREADS**



Description	Product No.
VICI cap kit	JR-S-32

Kit includes:	Qty	Product No.
VICI caps, GL45, two ports	3	JR-S-11001
VICI cap, GL45, three ports	1	JR-S-11002
Air inlet valves with 4 mm filters	4	JR-S-20003
PP plug	1	JR-201999
Carrying case	1	JR-S-31L

MULTI CAPS **PAGES 80-82**

VICI's **NEW** multi caps can be used either for mobile phase or for waste bottles/canisters. Thread sizes include GL38, GL45, DIN50, S51, B53, DIN60, S61, GLS80, and B83.

All multi caps come with a set of angled PA barbed adapters for connecting tubing with 4mm, 6mm and 8mm ID, as well as a PA plug for the M10x1 bore and PP plugs for the 1/4-28 bores.



GL38 threads
JR-S-13011



GL45 threads
JR-S-11052



DIN60 threads
JR-S-16052



GLS80 threads
JR-S-18053

PEEK SAMPLE LOOPS

PAGE 95

PEEK sample loops with volumes of 1, 2, 3 and 4 microliters are available for all types of valves – Cheminert, Valco, and Rheodyne.



NEW For Cheminert valves

Fit all Cheminert C1, C1CF, C2, C2V, and C3 type valves.

Sample size	Pressure *		Product No.
	bar	psi	
1 µl	480	7000	JR-SLC-85-1
2 µl	460	6700	JR-SLC-85-2
3 µl	460	6700	JR-SLC-85-3
4 µl	460	6700	JR-SLC-85-4

NEW For Valco valves

Fit all 1/16" Valco W and UW type valves.

Sample size	Pressure *		Product No.
	bar	psi	
1 µl	480	7000	JR-SLV-75-1
2 µl	460	6700	JR-SLV-75-2
3 µl	460	6700	JR-SLV-75-3
4 µl	460	6700	JR-SLV-75-4



NEW For Rheodyne valves

Fit all Rheodyne metal and metal-free valves.

Sample size	Pressure *		Product No.
	bar	psi	
1 µl	480	7000	JR-SLR-2190
2 µl	460	6700	JR-SLR-2191
3 µl	460	6700	JR-SLR-2192
4 µl	460	6700	JR-SLR-2193



ACCESSORIES

NEW HPLC Backpressure regulators

PAGE 102

Our newest backpressure regulator is made from stainless steel, rated up to 300 bar (4200 psi). It can be used for preparative and SFC applications.



	Range		Housing	Product No.
	90-300 bar	1300-4200 psi		
Stainless steel			SS	JR-BPR3

NEW Utility box

PAGE 105

This empty toolbox can be equipped by each individual. Utility boxes help store all the chromatographic accessories in the lab; moreover, they can be easily moved to wherever the chromatographic system is located.



	Product No.
Utility box	JR-35U

TUBING



METAL AND POLYMERIC

We offer chromatography grade tubing in a variety of polymers as well as stainless steel. Outside diameters are 360 µm, 1/32", 1/16", 1/8", and 1/4".

TUBING INDEX

PEEK TUBING

Natural PEEK.....	page 9
Available in ODs from 360 micron to 1/4", in custom lengths (priced per meter) and packages of 1.5m, 3m, and 10m	
Striped color-coded PEEK	10
A stripe is added to the outside of the tubing, so dye never contacts the fluid stream.	
Dual-layer PEEK	11
With an inner layer of natural PEEK and an outer layer of color-coded PEEK, there is no possibility of stream contents coming in contact with coloring agents.	
Solid color-coded PEEK.....	12
Color coding identifies the ID of your PEEK tubing. Each ID is coded with a different color.	

OTHER POLYMERIC TUBING

PFA	13
ETFE.....	13
PTFE	
Solid color-coded.....	14
Natural	15
FEP	16
Thermo-formed polymeric tubing ..	17
Impermeable tubing.....	17
FEP coated with PVDF combines the chemical resistance of FEP with the tight, impermeable structure of PVDF.	

STAINLESS STEEL TUBING

Bulk SS tubing	
Premium grade, seamless	19
Standard grade, welded seam ...	19
Pre-cut SS tubing	
Standard	20
Flexible.....	21

! DISCLAIMER

The maximum holding pressure for any type of connections involving tubing and a ferrule varies considerably with the tubing material, the ferrule material, the clearance between tubing OD and ferrule ID, and the shape of the fitting detail.

➔ SEE ALSO

SolviFlex	
coiled tubing	84
Tubing tools and accessories	
Easy-Flange kit	99
Easy-Flange combi kit ..	99
PEEK tubing elbows ..	100
Tubing cutters for:	
Polymeric tubing	
Clean-cut	100
Guillotine.....	100
Stainless tubing	
Wheel type	101
Plier type	101
Tubing clip – the LC tubing organizer....	100



NATURAL PEEK TUBING

PEEK tubing has the strength required to withstand continuous use at HPLC pressure without swelling or bursting, and is not affected by halide salts, high strength buffers, or other aggressive mobile phases that corrode stainless steel. The polymer surface will not leach metal ions into the eluent or extract metal-sensitive components from the sample. Note however that dichloromethane, THF, and DMSO may cause swelling in PEEK, and concentrated acids like nitric and sulphuric acid will attack PEEK.



NATURAL PEEK TUBING
shown with ODs of
1/8", 1/16", 1/32", and 360 µm

i PEEK TUBING TOLERANCES

Due to tighter tolerances, VICI Jour PEEK tubing is the best choice for chromatography applications in which exact flow rates or tube volume are of importance. The tighter tolerance ensures a more consistent internal volume of transfer lines.

Tubing OD	OD and ID (±)
1/32"	0.025 mm
1/16"	0.025 mm
1/8"	0.075 mm
1/4"	0.100 mm

t TECH TIP

- A clean burr-free perpendicular cut can be achieved with our Clean-cut cutter for polymeric tubing . . . 100
- To bend PEEK tubing at the optimal radius, use our tubing elbows . . . 100

➔ MORE INFO

- About PEEK® 113
- Chemical resistance PEEK 110-112
- PEEK at higher temperatures 110
- Maximum working pressure 108
- Tubing ID chart: volume per length . . . 107
- Tubing tolerances 109

➔ SEE ALSO

- Clean-cut polymeric tubing cutter 100
- Easy-Flange kit 99
- PEEK fittings High pressure 24-35
- Low pressure 48, 50-53
- PEEK tubing elbows . . . 100

SPECIFICATIONS

MAXIMUM RECOMMENDED WORKING TEMPERATURE
100°C (continuous) for 1/16" OD tubing with ID up to 0.75 mm

MAX WORKING PRESSURES AT ROOM TEMPERATURE
See page 108

OPTIONS

- Contact your distributor for more information about:
- Longer bulk tubing lengths
 - Customized ODs and IDs

PEEK tubing – natural

OD	ID (mm)	1.5 m	3 m	10 m
		Product No.	Product No.	Product No.
1/32"	0.13	JR-T-5993-M1.5	JR-T-5993-M3	JR-T-5993-M10
	0.15	JR-T-5706-M1.5 <i>NEW</i>	JR-T-5706-M3 <i>NEW</i>	JR-T-5706-M10 <i>NEW</i>
1/8"	0.75	—	JR-T-60041-M3	JR-T-60041-M10
	1.59	—	JR-T-6004-M3	JR-T-6004-M10
	2.00	—	JR-T-60042-M3	JR-T-60042-M10

OD	ID (mm)	per meter	
		Product No.	Tubing tolerance: OD ± 0.037 mm; ID ± 0.0013 mm
1/16"	0.064	JR-T-5998-0005 <i>NEW</i>	
	0.38	JR-T-62015	
1/4"	3.17	JR-T-6006	

↔ CONVERSIONS

75 µm = .003"
0.013 mm = .0005"
0.025 mm = .001"
0.064 mm = .0025"
0.075 mm = .003"
0.100 mm = .004"
0.13 mm = .005"
0.15 mm = .006"
0.38 mm = .015"
0.75 mm = .03"
1.59 mm = 1/16"
2.00 mm = .08"
3.17 mm = 1/8"
1.5 m = 4.92'
3.0 m = 9.84'
10.0 m = 32.8'

? WHICH PEEK TUBING FOR WHICH APPLICATION?

Application	Tubing
Standard HPLC*	1/16" OD x 0.25 mm ID
High pressure semi-prep LC*	1/8" OD
Agilent 1100 LC systems**	1/32"
Most capillary systems	360 µm

* Smaller ID for low flow rates/higher ID for high flow rates. Note that a low linear flow rate causes peak broadening.

**For some 1100 LC systems with high pressure flow paths

t TECH TIP: STRAIGHTENING PEEK TUBING

1. Start with stainless steel tubing:
ID slightly larger than OD of PEEK
Length = 2 cm shorter than PEEK
2. Slide PEEK tubing into stainless tubing, extending 1 cm out each end of the stainless
3. Place sleeved PEEK tubing into oven:
220°C for 30 minutes, or
180°C for 60 minutes
4. Allow sleeved tubing to cool in oven to ambient temperature
5. Once tubing is cooled, remove PEEK tubing from the SS sleeve
6. Check for straightness
7. Repeat if necessary



STRIPED COLOR-CODED PEEK TUBING

We recommend striped PEEK tubing for easy color-coded identification of tubing ID, with maximum chemical resistance and biocompatibility. The stripe is added to the outside, so dye never contacts the fluid stream.

All colorants used in the manufacture of this tubing are RoHS-compliant. (Restriction of Hazardous Substances)

SPECIFICATIONS

MAXIMUM RECOMMENDED WORKING TEMPERATURE
100°C (continuous) for 1/16" OD tubing with ID up to 0.75 mm

MAX WORKING PRESSURES AT ROOM TEMPERATURE
See page 108

TUBING TOLERANCES

Tubing OD	OD and ID (±)
1/32"	0.025 mm
1/16"	0.025 mm

OPTIONS

Contact your distributor or VICI about:

- Longer bulk tubing lengths
- Customized ODs and IDs

1/32" OD

PRE-CUT LENGTHS

ID (mm)	Color	NEW		
		1 m Product No.	1.5 m Product No.	3 m Product No.
0.050	Orange	JR-T-5702-M1	JR-T-5702-M1.5	JR-T-5702-M3
0.064	Red	JR-T-5764-M1	JR-T-5764-M1.5	JR-T-5764-M3
0.075	Green	JR-T-5703-M1	JR-T-5703-M1.5	JR-T-5703-M3
0.10	Black	JR-T-5704-M1	JR-T-5704-M1.5	JR-T-5704-M3
0.13	Red	JR-T-5705-M1	JR-T-5705-M1.5	JR-T-5705-M3
0.18	Yellow	JR-T-5707-M1	JR-T-5707-M1.5	JR-T-5707-M3
0.20	Orange	JR-T-5708-M1	JR-T-5708-M1.5	JR-T-5708-M3
0.25	Blue	JR-T-5710-M1	JR-T-5710-M1.5	JR-T-5710-M3
0.50	Orange	JR-T-5720-M1	JR-T-5720-M1.5	JR-T-5720-M3



1/16" OD

PRE-CUT LENGTHS

ID (mm)	Color	NEW	NEW	NEW	NEW	NEW	NEW
		1.5 m Product No.	3 m Product No.	5 m Product No.	10 m Product No.	15 m Product No.	25 m Product No.
0.050	Orange	JR-T-5802-M1.5	JR-T-5802-M3	JR-T-5802-M5	JR-T-5802-M10	JR-T-5802-M15	JR-T-5802-M25
0.075	Green	JR-T-5803-M1.5	JR-T-5803-M3	JR-T-5803-M5	JR-T-5803-M10	JR-T-5803-M15	JR-T-5803-M25
0.10	Black	JR-T-5804-M1.5	JR-T-5804-M3	JR-T-5804-M5	JR-T-5804-M10	JR-T-5804-M15	JR-T-5804-M25
0.13	Red	JR-T-5999-M1.5	JR-T-5999-M3	JR-T-5999-M5	JR-T-5999-M10	JR-T-5999-M15	JR-T-5999-M25
0.18	Yellow	JR-T-6000-M1.5	JR-T-6000-M3	JR-T-6000-M5	JR-T-6000-M10	JR-T-6000-M15	JR-T-6000-M25
0.25	Blue	JR-T-6001-M1.5	JR-T-6001-M3	JR-T-6001-M5	JR-T-6001-M10	JR-T-6001-M15	JR-T-6001-M25
0.50	Orange	JR-T-6002-M1.5	JR-T-6002-M3	JR-T-6002-M5	JR-T-6002-M10	JR-T-6002-M15	JR-T-6002-M25
0.75	Green	JR-T-6003-M1.5	JR-T-6003-M3	JR-T-6003-M5	JR-T-6003-M10	JR-T-6003-M15	JR-T-6003-M25
1.00	Grey	JR-T-60031-M1.5	JR-T-60031-M3	JR-T-60031-M5	JR-T-60031-M10	JR-T-60031-M15	JR-T-60031-M25
1.40	Black	JR-T-60032-M1.5	JR-T-60032-M3	JR-T-60032-M5	JR-T-60032-M10	JR-T-60032-M15	JR-T-60032-M25

CONVERSIONS

50 µm = .002"	0.20 mm = .008"
75 µm = .003"	0.25 mm = .01"
100 µm = .004"	0.50 mm = .02"
125 µm = .005"	0.75 mm = .03"
150 µm = .006"	1.00 mm = .04"
0.013 mm = .0005"	1.40 mm = .055"
0.025 mm = .001"	
0.050 mm = .002"	1.5 m = 4.92'
0.064 mm = .0025"	3.0 m = 9.84'
0.075 mm = .003"	5.0 m = 16.40'
0.10 mm = .004"	10.0 m = 32.80'
0.13 mm = .005"	15.0 m = 49.21'
0.18 mm = .007"	25.0 m = 82.02'

TECH TIP

VICI Jour sample loops for analytical applications are made of PEEK striped color-coded tubing.
PEEK loops 95

SEE ALSO

Clean-cut polymeric tubing cutter 100
Easy-Flange kit 99
PEEK fittings
High pressure . . . 24-35
Low pressure . 48, 50-53
PEEK tubing elbows . 100



SPECIFICATIONS

MAXIMUM RECOMMENDED WORKING TEMPERATURE
100°C (continuous)

TUBING TOLERANCES

Tubing OD	OD and ID (±)
1/16"	0.025 mm

OPTIONS

Contact your distributor or VICI about:

- Longer bulk tubing lengths
- Customized ODs and IDs

DUAL LAYER COLOR-CODED PEEK TUBING

- Inner layer of natural PEEK, outer layer of color-coded PEEK
- No possibility of stream coming in contact with coloring agents
- Pressure performance equivalent to single layer tubing
- 1/16" OD, IDs from 0.10 to 0.75 mm

Our dual layer PEEK tubing eliminates any concern that a critical sample stream could be contaminated by pigments used to color code the tubing. It looks like any other color-coded tubing at first glance, but a closer look reveals that the pigmented layer* surrounds a separate but integrally-bonded inner layer of natural PEEK. Only natural PEEK is in contact with the fluid stream.



*All colorants used in the manufacture of this tubing are RoHS-compliant. (Restriction of Hazardous Substances)

1/16" OD

PRE-CUT LENGTHS

ID (mm)	Color	bar	psi	NEW		NEW		NEW	
				1.5 m	3 m	10 m	15 m	25 m	
				Product No.	Product No.	Product No.	Product No.	Product No.	
0.10	Black	460	6700	JR-TD-5804-M1.5	JR-TD-5804-M3	JR-TD-5804-M10	JR-TD-5804-M15	JR-TD-5804-M25	
0.13	Red	420	6100	JR-TD-6007-M1.5	JR-TD-6007-M3	JR-TD-6007-M10	JR-TD-6007-M15	JR-TD-6007-M25	
0.18	Yellow	400	5800	JR-TD-6008-M1.5	JR-TD-6008-M3	JR-TD-6008-M10	JR-TD-6008-M15	JR-TD-6008-M25	
0.25	Blue	386	5600	JR-TD-6009-M1.5	JR-TD-6009-M3	JR-TD-6009-M10	JR-TD-6009-M15	JR-TD-6009-M25	
0.50	Orange	350	4500	JR-TD-6010-M1.5	JR-TD-6010-M3	JR-TD-6010-M10	JR-TD-6010-M15	JR-TD-6010-M25	
0.75	Green	240	3500	JR-TD-6011-M1.5	JR-TD-6011-M3	JR-TD-6011-M10	JR-TD-6011-M15	JR-TD-6011-M25	

MORE INFO

- About PEEK® 113
- Chemical resistance
PEEK 110=112
- PEEK at higher temperatures 110
- Maximum working pressure 108
- Tubing ID chart:
volume per length . . . 107
- Tubing tolerances . . . 109

SEE ALSO

- Solid color-coded PEEK tubing 12
- Clean-cut polymeric tubing cutter 100



SOLID COLOR-CODED PEEK TUBING

Color-coding identifies the ID of your PEEK tubing – each ID is coded with a different color. Solid colored tubing is made of pre-dyed raw material.

All colorants used in the manufacture of this tubing are RoHS-compliant. (Restriction of Hazardous Substances)

1/32" OD

PRE-CUT LENGTHS

For natural PEEK tubing, see page 9.

ID (mm)	Color	1 m	3 m
		Product No.	Product No.
0.050	Orange	JR-T-5602-M1	JR-T-5602-M3
0.064	Red	JR-T-5664-M1	JR-T-5664-M3
0.075	Green	JR-T-5603-M1	JR-T-5603-M3
0.10	Black	JR-T-5604-M1	JR-T-5604-M3
0.13	Red	JR-T-5605-M1	JR-T-5605-M3
0.15	Purple	JR-T-5606-M1	JR-T-5606-M3
0.18	Yellow	JR-T-5607-M1	JR-T-5607-M3
0.20	Orange	JR-T-5608-M1	JR-T-5608-M3
0.25	Blue	JR-T-5610-M1	JR-T-5610-M3
0.50	Orange	JR-T-5620-M1	JR-T-5620-M3

SPECIFICATIONS

MAXIMUM RECOMMENDED WORKING TEMPERATURE

100°C (continuous) for 1/16" OD tubing with ID up to 0.75 mm

MAX WORKING PRESSURES AT ROOM TEMPERATURE

See page 108

TUBING TOLERANCES

Tubing OD	OD and ID (±)
1/32"	0.025 mm
1/16"	0.025 mm

OPTIONS

Contact your distributor or VICI about:

- Longer bulk tubing lengths
- Customized ODs and IDs

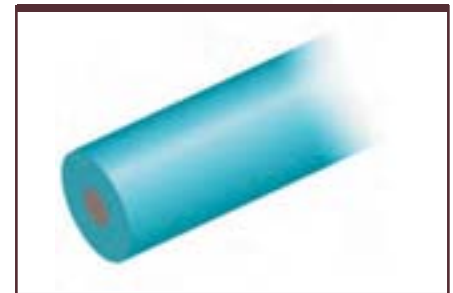

1/16" OD

PRE-CUT LENGTHS

For natural PEEK tubing, see page 9.

ID (mm)	Color	NEW 1.5 m	3 m	10 m	NEW 15 m	25 m
		Prod No	Prod No	Prod No	Product No.	Product No.
0.10	Black	JR-T-6020-M1.5	JR-T-6020-M3	JR-T-6020-M10	JR-T-6020-M15	JR-T-6020-M25
0.13	Red	JR-T-6007-M1.5	JR-T-6007-M3	JR-T-6007-M10	JR-T-6007-M15	JR-T-6007-M25
0.15	Purple	JR-T-6030-M1.5	JR-T-6030-M3	JR-T-6030-M10	JR-T-6030-M15	JR-T-6030-M25
0.18	Yellow	JR-T-6008-M1.5	JR-T-6008-M3	JR-T-6008-M10	JR-T-6008-M15	JR-T-6008-M25
0.25	Blue	JR-T-6009-M1.5	JR-T-6009-M3	JR-T-6009-M10	JR-T-6009-M15	JR-T-6009-M25
0.38	Grey	JR-T-6040-M1.5	JR-T-6040-M3	JR-T-6040-M10	JR-T-6040-M15	JR-T-6040-M25
0.50	Orange	JR-T-6010-M1.5	JR-T-6010-M3	JR-T-6010-M10	JR-T-6010-M15	JR-T-6010-M25
0.75	Green	JR-T-6011-M1.5	JR-T-6011-M3	JR-T-6011-M10	JR-T-6011-M15	JR-T-6011-M25

TECH TIP

See our dual layer PEEK tubing for solid colored PEEK tubing with no possibility of stream coming into contact with coloring agents. 11

MORE INFO

About PEEK® 113
 Chemical resistance
 PEEK 110-112
 PEEK at higher temperatures 110
 Maximum working pressure 108
 Tubing ID chart:
 volume per length . . 107
 Tubing tolerances . . . 109

SEE ALSO

Clean-cut polymeric tubing cutter 100
 Easy-Flange kit 99
 PEEK fittings
 High pressure . . . 24-35
 Low pressure . 48, 50-53
 PEEK tubing elbows . . 100



**SPECIFICATIONS –
ETFE AND PFA**

MAX WORKING PRESSURES

See page 108

TUBING TOLERANCES

Tubing OD	OD and ID (±)
1/16" *	0.05 mm
1/8"	0.10 mm
1/4"	0.10 mm OD
	0.20 mm ID

* ETFE with 0.20 mm ID:
OD ± 0.07
Wall ± 0.08

OPTIONS

Contact your distributor or VICI about:

- Longer tubing lengths at competitive bulk prices
- Customized ODs and IDs

ETFE TUBING

ETFE (ethyltrifluoroethylene) tubing is particularly suitable for HPLC, since it has a higher burst pressure as compared to PTFE. 1/16" OD x 0.25 mm ID tubing will withstand up to 186 bar (2700 psi) with water as mobile phase. However, it is important to note that when used with organic solvents, ETFE tubing may swell, reducing that maximum pressure to 70 bar (1000 psi).

This is the ideal polymer for applications with chloride salts, which typically corrode stainless steel.

OD	ID (mm)	NEW			NEW	
		1.5 m	3 m	10 m	15 m	25 m
Product No.	Product No.	Product No.	Product No.	Product No.	Product No.	Product No.
1/32"	0.25	JR-T-084-M1.5	JR-T-084-M3	JR-T-084-M10	JR-T-084-M15	JR-T-084-M25
1/16"	0.20	JR-T-079-M1.5	JR-T-079-M3	JR-T-079-M10	JR-T-079-M15	JR-T-079-M25
	0.25	JR-T-080-M1.5	JR-T-080-M3	JR-T-080-M10	JR-T-080-M15	JR-T-080-M25
	0.50	JR-T-082-M1.5	JR-T-082-M3	JR-T-082-M10	JR-T-082-M15	JR-T-082-M25
	0.75	JR-T-083-M1.5	JR-T-083-M3	JR-T-083-M10	JR-T-083-M15	JR-T-083-M25
	1.00	JR-T-085-M1.5	JR-T-085-M3	JR-T-085-M10	JR-T-085-M15	JR-T-085-M25
1/8"	1.59	JR-T-086-M1.5	JR-T-086-M3	JR-T-086-M10	JR-T-086-M15	JR-T-086-M25
	2.40	JR-T-089-M1.5	JR-T-089-M3	JR-T-089-M10	JR-T-089-M15	JR-T-089-M25

OD	ID (mm)	1 m	3 m
		Product No.	Product No.
3.0 mm	1.0	JR-T-087-M1	JR-T-087-M3
6.0 mm	4.0	JR-T-088-M1	JR-T-088-M3
6.4 mm	4.8	JR-T-090-M1 NEW	JR-T-090-M3 NEW



PFA TUBING

PFA (perfluoroalkoxy) tubing from VICI Jour has excellent chemical stability and mechanical strength. 1/16" OD high purity tubing has a maximum pressure rating of up to 100 bar (1450 psi), while 1/8" OD tubing can be used at up to 72 bar (1050 psi).

Always use PFA instead of PTFE if gas permeability is an issue.

OD	ID (mm)	NEW			NEW	
		1.5 m	3 m	10 m	15 m	25 m
Product No.	Product No.	Product No.	Product No.	Product No.	Product No.	Product No.
1/16"	0.50	JR-T-4001-M1.5	JR-T-4001-M3	JR-T-4001-M10	JR-T-4001-M15	JR-T-4001-M25
	0.75	JR-T-4002-M1.5	JR-T-4002-M3	JR-T-4002-M10	JR-T-4002-M15	JR-T-4002-M25
	1.00	JR-T-4007-M1.5	JR-T-4007-M3	JR-T-4007-M10	JR-T-4007-M15	JR-T-4007-M25
1/8"	1.59	JR-T-4003-M1.5	JR-T-4003-M3	JR-T-4003-M10	JR-T-4003-M15	JR-T-4003-M25

OD	ID (mm)	per meter
		Product No.
1/8"	1.70	JR-T-4005
3/16"	3.20	JR-T-4009
1/4"	3.97	JR-T-4006 NEW
	4.35	JR-T-4004
	4.80	JR-T-4008 NEW



TECH TIP

- When selecting tubing for low pressure applications, give careful consideration to gas permeability characteristics.
- Use PFA instead of PTFE if gas permeability is an issue.

MORE INFO

About ETFE. 113
 Chemical resistance . . 110
 Maximum working pressure 108
 Tubing ID chart: volume per length. . 107
 Tubing tolerances . . . 109

SEE ALSO

Clean-cut polymeric tubing cutter 100
 Easy-Flange kit 99
 Low pressure fittings 46-55
 SolviFlex coiled PFA tubing 84

CONVERSIONS

50 µm = .002"	0.13 mm = .005"	3.97 mm = .156"
75 µm = .003"	0.15 mm = .006"	4.0 mm = .16"
100 µm = .004"	0.18 mm = .007"	4.35 mm = .17"
125 µm = .005"	0.20 mm = .008"	4.8 mm = .19"
150 µm = .006"	0.25 mm = .01"	1.0 m = 3.28'
0.013 mm = .0005"	0.38 mm = .015"	1.5 m = 4.92'
0.025 mm = .001"	0.50 mm = .02"	3.0 m = 9.84'
0.050 mm = .002"	0.75 mm = .03"	5.0 m = 16.40'
0.064 mm = .0025"	1.00 mm = .04"	10.0 m = 32.80'
0.075 mm = .003"	1.59 mm = 1/16"	15.0 m = 49.21'
0.07 mm = .0027"	1.70 mm = .067"	25.0 m = 82.02'
0.08 mm = .0031"	2.40 mm = .094"	
0.10 mm = .004"	3.20 mm = .126"	



TUBING

PTFE TUBING

PTFE (polytetrafluoroethylene) tubing is chemically inert and suitable for lower pressure applications. Typically 1/16" OD tubing holds up to 62 bar (900 psi) and 1/8" up to 35 bar (500 psi). Maximum continuous operating temperature is 100°C.

PTFE tubing – solid color-coded

Solid colors identify the tubing ID.

Black PTFE, available in two IDs, is recommended for light sensitive applications such as enzymatic reactions, luminescent reactions, connecting to a flow cell, and radioactive HPLC.

OD	ID (mm)	Color	3 m Product No.	10 m Product No.	25 m Product No.
1/16"	0.25	Blue	JR-T-4011C-M3	JR-T-4011C-M10	JR-T-4011C-M25
	0.25	Black	JR-T-6808-M3	JR-T-6808-M10	JR-T-6808-M25
	0.50	Black	JR-T-6811-M3	JR-T-6811-M10	JR-T-6811-M25
	0.50	Orange	JR-T-4183C-M3	JR-T-4183C-M10	JR-T-4183C-M25
	0.75	Green	JR-T-4036C-M3	JR-T-4036C-M10	JR-T-4036C-M25



SPECIFICATIONS

MAXIMUM RECOMMENDED WORKING TEMPERATURE

100°C (continuous)

MAX WORKING PRESSURES AT ROOM TEMPERATURE

See page 108

TUBING TOLERANCES

Tubing OD	OD and ID (±)
1/16"	0.05 mm
1/8"	0.10 mm
1/4"	0.10 mm
1/2"	0.20 mm

OPTIONS

Contact your distributor or VICI about:

- Longer tubing lengths at competitive bulk prices
- Customized ODs and IDs

t TECH TIP

Use PFA instead of PTFE if gas permeability is an issue.

t TECH TIP

Use black PTFE for light sensitive applications such as enzymatic reactions, luminescent reactions, connecting to a flow cell, and radioactive HPLC.

➔ MORE INFO

About PTFE. 104
 Chemical resistance . . 110
 Maximum working pressure 108
 Tubing ID chart:
 volume per length . . 107
 Tubing tolerances . . . 109

➔ SEE ALSO

Clean-cut polymeric tubing cutter 100
 Easy-Flange kit 99
 Flanged fittings. . . . 47, 49
 Flangeless fittings . . 47-48



PTFE tubing – natural color

OD	ID (mm)	NEW	3 m	5 m	10 m	NEW	25 m
		1.5 m				15 m	
		Product No.	Product No.	Product No.	Product No.	Product No.	Product No.
1/16"	0.18	JR-T-6805-M1.5	JR-T-6805-M3	JR-T-6805-M5	JR-T-6805-M10	JR-T-6805-M15	JR-T-6805-M25
	0.25	JR-T-4011-M1.5	JR-T-4011-M3	JR-T-4011-M5	JR-T-4011-M10	JR-T-4011-M15	JR-T-4011-M25
	0.50	JR-T-4183-M1.5	JR-T-4183-M3	JR-T-4183-M5	JR-T-4183-M10	JR-T-4183-M15	JR-T-4183-M25
	0.75	JR-T-4036-M1.5	JR-T-4036-M3	JR-T-4036-M5	JR-T-4036-M10	JR-T-4036-M15	JR-T-4036-M25
	1.00	JR-T-6807-M1.5	JR-T-6807-M3	JR-T-6807-M5	JR-T-6807-M10	JR-T-6807-M15	JR-T-6807-M25
1/8"	1.59	JR-T-6800-M1.5	JR-T-6800-M3	JR-T-6800-M5	JR-T-6800-M10	JR-T-6800-M15	JR-T-6800-M25
	2.40	JR-T-4037-M1.5	JR-T-4037-M3	JR-T-4037-M5	JR-T-4037-M10	JR-T-4037-M15	JR-T-4037-M25

OD	ID (mm)	NEW	3 m	10 m	NEW	25 m
		1.5 m			15 m	
		Product No.	Product No.	Product No.	Product No.	Product No.
2 mm	1.70	JR-T-6801-M1.5	JR-T-6801-M3	JR-T-6801-M10	JR-T-6801-M15	JR-T-6801-M25
4 mm	3.00	JR-T-4039-M1.5	JR-T-4039-M3	JR-T-4039-M10	—	—

Tubing OD		ID	per meter Product No.
in.	mm		
3/16"	4.76	3.76 mm	JR-T-4041
0.236"	6.00	4.00	JR-T-4042 NEW
1/4"	6.35	4.76 mm	JR-T-6810 NEW
0.315"	8.00	6.00 mm	JR-T-4050 NEW
1/2"	12.7	9.53 mm	JR-T-4043 NEW

CONVERSIONS

50 µm = .002"	0.13 mm = .005"	3.97 mm = .156"
75 µm = .003"	0.15 mm = .006"	4.0 mm = .16"
100 µm = .004"	0.18 mm = .007"	4.35 mm = .17"
125 µm = .005"	0.20 mm = .008"	4.8 mm = .19"
150 µm = .006"	0.25 mm = .01"	1.0 m = 3.28'
0.013 mm = .0005"	0.38 mm = .015"	1.5 m = 4.92'
0.025 mm = .001"	0.50 mm = .02"	3.0 m = 9.84'
0.050 mm = .002"	0.75 mm = .03"	5.0 m = 16.40'
0.064 mm = .0025"	1.00 mm = .04"	10.0 m = 32.80'
0.075 mm = .003"	1.59 mm = 1/16"	15.0 m = 49.21'
0.07 mm = .0027"	1.70 mm = .067"	25.0 m = 82.02'
0.08 mm = .0031"	2.40 mm = .094"	
0.10 mm = .004"	3.20 mm = .126"	



TUBING

FEP TUBING

FEP (FluorinatedEthylenePropylene) tubing is chemically inert to most HPLC solvents, and is recommended for low pressure applications. Typically 1/16" OD tubing holds up to 117 bar (1700 psi), and 1/8" OD holds up to 70 bar (1000 psi).

We recommend FEP for ion chromatography applications.

		1 m	3 m	10 m
OD	ID (mm)	Product No.	Product No.	Product No.
1/32"	0.13	JR-T-6605-M1	JR-T-6605-M3	JR-T-6605-M10
	0.15	JR-T-6606-M1	JR-T-6606-M3	JR-T-6606-M10
	0.18	JR-T-6607-M1	JR-T-6607-M3	JR-T-6607-M10
	0.20	JR-T-6797-M1	JR-T-6797-M3	JR-T-6797-M10
	0.25	JR-T-6610-M1	JR-T-6610-M3	JR-T-6610-M10
	0.38	JR-T-6615-M1	JR-T-6615-M3	JR-T-6615-M10
	0.40	JR-T-6798-M1	JR-T-6798-M3	JR-T-6798-M10
	0.50	JR-T-6620-M1	JR-T-6620-M3	JR-T-6620-M10

		NEW 1.5 m	3 m	10 m	NEW 15 m	25 m
OD	ID (mm)	Product No.	Product No.	Product No.	Product No.	Product No.
1/16"	0.25	JR-T-6812-M1.5	JR-T-6812-M3	JR-T-6812-M10	JR-T-6812-M15	JR-T-6812-M25
	0.30	JR-T-6702-M1.5	JR-T-6702-M3	JR-T-6702-M10	JR-T-6702-M15	JR-T-6702-M25
	0.50	JR-T-6802-M1.5	JR-T-6802-M3	JR-T-6802-M10	JR-T-6802-M15	JR-T-6802-M25
	0.75	JR-T-6803-M1.5	JR-T-6803-M3	JR-T-6803-M10	JR-T-6803-M15	JR-T-6803-M25
	1.00	JR-T-6806-M1.5	JR-T-6806-M3	JR-T-6806-M10	JR-T-6806-M15	JR-T-6806-M25
1/8"	1.59	JR-T-6804-M1.5	JR-T-6804-M3	JR-T-6804-M10	JR-T-6804-M15	JR-T-6804-M25
	2.10	JR-T-6813-M1.5	JR-T-6813-M3	JR-T-6813-M10	JR-T-6813-M15	JR-T-6813-M25
3/16"	3.18	JR-T-6835-M1.5	JR-T-6835-M3	JR-T-6835-M10	JR-T-6835-M15	JR-T-6835-M25
1 mm	0.50	JR-T-6105-M1.5	JR-T-6105-M3	JR-T-6105-M10	JR-T-6105-M15	JR-T-6105-M25
2 mm	1.00	JR-T-6210-M1.5	JR-T-6210-M3	JR-T-6210-M10	JR-T-6210-M15	JR-T-6210-M25
3 mm	1.00	JR-T-6310-M1.5	JR-T-6310-M3	JR-T-6310-M10	JR-T-6310-M15	JR-T-6310-M25
	2.00	JR-T-6320-M1.5	JR-T-6320-M3	JR-T-6320-M10	JR-T-6320-M15	JR-T-6320-M25

		per meter	
OD	ID (mm)	Product No.	
4 mm	3.00	JR-T-6860	NEW
1/4"	3.96	JR-T-6840	NEW
	4.35	JR-T-6809	
	3/16"	JR-T-6841	NEW
5/16"	1/4"	JR-T-6650	NEW

CONVERSIONS

0.05 mm = .002"	0.50 mm = .02"	3.76 mm = .15"	1.0 m = 3.28'
0.10 mm = .004"	0.75 mm = .03"	3.96 mm = .156"	1.5 m = 4.92'
0.13 mm = .005"	1.00 mm = .04"	4.00 mm = .157"	3.0 m = 9.84'
0.15 mm = .006"	1.59 mm = 1/16"	4.35 mm = .17"	5.0 m = 16.40'
0.18 mm = .007"	1.70 mm = .067"	4.76 mm = 3/16"	10.0 m = 32.80'
0.20 mm = .008"	2.00 mm = .08"	4.80 mm = .189"	15.0 m = 49.21'
0.25 mm = .01"	2.10 mm = .083"	6.00 mm = .24"	25.0 m = 82.02'
0.30 mm = .012"	2.40 mm = .094"	6.35 mm = 1/4"	
0.38 mm = .015"	3.00 mm = .12"	7.94 mm = 5/16"	
0.40 mm = .016"	3.18 mm = 1/8"	9.35 mm = 3/8"	

SPECIFICATIONS

MAXIMUM RECOMMENDED WORKING TEMPERATURE

80°C (continuous)

MAX WORKING PRESSURES AT ROOM TEMPERATURE

See page 108

TUBING TOLERANCES

Tubing OD	OD and ID (±)
1/32"	0.025 mm
1/16"	0.08 mm
1/8"	0.10 mm
1/4"	0.10 mm OD
	0.20 mm ID

OPTIONS

Contact your distributor or VICI about:

- Longer tubing lengths at competitive bulk prices
- Customized ODs and IDs



TECH TIP

When selecting tubing for low pressure applications, give careful consideration to gas permeability characteristics.

MORE INFO

About FEP.....113
 Chemical resistance ..110
 Maximum working pressure108
 Tubing ID chart:
 volume per length ..107
 Tubing tolerances109

SEE ALSO

Clean-cut polymeric tubing cutter100
 Easy-Flange kit99
 Low pressure fittings46-55

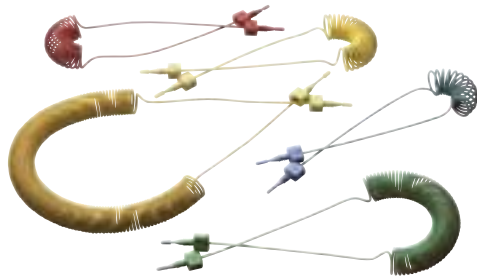

THERMO-FORMED POLYMERIC TUBING

- Available in a variety of polymers
- Provides axial flexibility
- Telephone cables or customer-specified shapes

VICI Jour offers thermo-formed tubing in various geometric shapes and polymers. The form will maintain its shape so long as the temperature does not exceed 100°C.

Straight tubing, spirals, or even more complex forms – just define your form and material on a drawing for us.

FOR PRICING
 Contact VICI or your local distributor for more information or a quotation.

SPECIFICATIONS

PRESSURE

Low pressure only

TUBING

1/8" OD 1.65 mm ID

TOLERANCES

±0.05 mm (.002")
 OD and ID

MATERIALS

Tubing: FEP coated with PVDF
 Insert PCTFE
 Ferrule ETFE
 Fitting PPS

OPTIONS

Contact us for more info about longer tubing lengths at competitive bulk prices.

IMPERMEABLE POLYMERIC TUBING

- FEP coated with PVDF
- Excellent chemical resistance
- For technical applications
- Prevents "re-gassing" after degassing in LC applications

PTFE and FEP have very good chemical resistance, but are too permeable to be suitable for mobile phase transfer lines. PVDF, on the other hand, lacks chemical resistance but is a very tight polymer with no observable micropores. Our impermeable tubing is produced by co-extruding PVDF over FEP to combine the best features of both polymers, ensuring that degassed solvent will stay degassed until it reaches the HPLC pump.

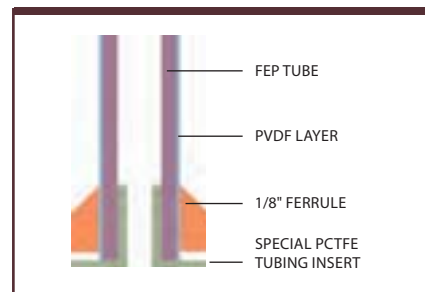

The PVDF layer can easily be stripped away with our Clean-Cut tubing cutter or a razor blade, leaving a length of exposed FEP to extend into the solvent reservoir.

When making connections, a special PCTFE tubing insert fits into the ID of the tubing and seals against the bottom of the port, preventing the solvent from contacting the PVDF layer at the end of the tube.

	3 m Product No.	10 m Product No.
Impermeable tubing, 1/8" OD x 1.65 mm ID	JR-T-6130-M3	JR-T-6130-M10

	Qty/pkg	Product No.
Additional spare parts		
PCTFE tubing inserts	10	JR-6141-10
1/8" PPS nuts	10	JR-55071-10
1/8" ETFE ferrules	10	JR-051-10
Fitting kit	<i>Contains:</i>	
	PCTFE tubing inserts	2
	1/8" PPS nuts	2
	1/8" ETFE ferrules	2
		JR-6140

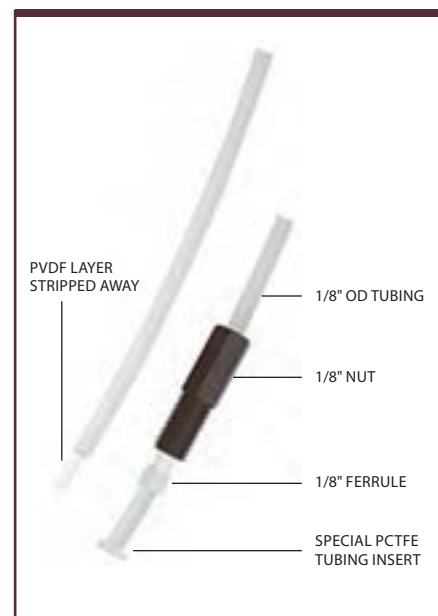

t TECH TIP

Use FEP or PFA tubing inside the solvent reservoir, since PVDF has limited chemical resistance.

t TECH TIP

Always use the specially-designed tubing insert to prevent solvent contact with the PVDF layer.

➔ MORE INFO

- About FEP 113
- About PVDF 114
- Chemical resistance . . 110
- Tubing ID chart:
 volume per length . . 107
- Tubing tolerances . . . 109

➔ SEE ALSO

- Clean-cut polymeric tubing cutter 100
- Color-sleeve fingertight adapters . 23



FUSED SILICA CAPILLARY TUBING **NEW**

Untreated fused silica (FS) capillaries

FS capillaries are manufactured by coating fused silica with a layer of polyimide, and consist of synthetically manufactured quartz glass in amorphous (non-crystalline) form.

Due to the polyimide coating, the tubing is flexible and robust. The tubing is stable at temperatures up to 350°C, and is ideal for applications in Micro- and Nano-LC.

FS capillaries are chemically inert. They can be used with organic solvents and in the pH range from 0 – 10.

Sold by the meter.

OD	ID	per meter Product No.
360 µm	25 µm	JR-T-7360-025
	50 µm	JR-T-7360-050
	75 µm	JR-T-7360-075
	100 µm	JR-T-7360-100
	150 µm	JR-T-7360-150
	180 µm	JR-T-7360-180



SPECIFICATIONS

MAXIMUM RECOMMENDED WORKING TEMPERATURE
350°C

PRESSURE RATING
Up to 6000 bar
(87,000 psi)

TOLERANCES
OD ± 5 µm (.002")
ID ± 5 µm (.002")

Note: Parameters for temperature and pressure ratings **are strongly dependent on bending, chemicals used, pressure, and temperature.**

t TECH TIP

Use our 360 µm Nanovolume® fittings to connect this tubing free of dead volume.

PEEK fittings 44
Stainless fittings 45

↔ CONVERSIONS

50 µm = .002"
75 µm = .003"
100 µm = .004"
0.13 mm = .005"
0.18 mm = .007"
0.25 mm = .01"
0.38 mm = .015"
0.50 mm = .02"
0.75 mm = .03"
1.00 mm = .04"
1.52 mm = XXXX
1.59 mm = 1/16"
1.70 mm = .067"
2.10 mm = .083"
2.16 mm = .XXX"
4.65 mm = .XXX"



STAINLESS STEEL TUBING

This is the standard tubing material for chromatography, suitable for a wide variety of applications. Close tolerances are held on both ID and OD.

Note that bulk tubing is roughly cut with tubing pliers, so the ends must be properly cut before use. For electrolytically-cut premium SS tubing, please order our pre-cut tubing (pages 20-21). Pre-cut tubing is steam cleaned and offers burr-free ends – ready to use for high end LC applications.

Stainless tubing – premium grade

UHPLC, HPLC, GC

SPECIFICATIONS

PRESSURE RATING

Values shown are minimum; rating varies with ID; (see page 107)

OD	bar	psi
360 µm	679	9857
1/32"	400	5800
1/16"	365	5300
1/8"	315	4600

TOLERANCES

Tubing ID	OD and ID (±)
50 µm	0.010 mm
75 µm	0.010 mm
100 µm	0.010 mm
all other ID's	0.025 mm

OPTIONS

Contact us for more info about longer tubing lengths at competitive bulk prices.

- Cold drawn, seamless Type 316 stainless steel
- Variety of sizes for UHPLC, HPLC, and GC applications
- Smooth internal surface
- Soft annealed OD for easy ferrule connections

Our premium grade seamless stainless steel tubing is the base for all high pressure and ultra-high pressure lines in your equipment.

OD	ID (mm)	Product No.			per meter Product No.
		1.5 m	3 m	10 m	
1/32"	0.13	JR-TSS.505-M1.5	JR-TSS.505-M3	JR-TSS.505-M10	360 µm
	0.18	JR-TSS.507-M1.5	JR-TSS.507-M3	JR-TSS.507-M10	
	0.25	JR-TSS.510-M1.5	JR-TSS.510-M3	JR-TSS.510-M10	150
	0.50	JR-TSS.520-M1.5	JR-TSS.520-M3	JR-TSS.520-M10	
1/16"	0.13	JR-TSS105-M1.5	JR-TSS105-M3	JR-TSS105-M10	per meter Product No.
	0.25	JR-TSS110-M1.5	JR-TSS110-M3	JR-TSS110-M10	
	0.38	JR-TSS115-M1.5	JR-TSS115-M3	JR-TSS115-M10	
	0.50	JR-TSS120-M1.5	JR-TSS120-M3	JR-TSS120-M10	
	0.75	JR-TSS130-M1.5	JR-TSS130-M3	JR-TSS130-M10	
	1.00	JR-TSS140-M1.5	JR-TSS140-M3	JR-TSS140-M10	
1/8"	0.75	JR-TSS230-M1.5	JR-TSS230-M3	JR-TSS230-M10	per meter Product No.
	1.00	JR-TSS240-M1.5	JR-TSS240-M3	JR-TSS240-M10	
	1.52	JR-TSS260-M1.5	JR-TSS260-M3	JR-TSS260-M10	
	1.70	JR-TSS267-M1.5	JR-TSS267-M3	JR-TSS267-M10	
	2.16	JR-TSS285-M1.5	JR-TSS285-M3	JR-TSS285-M10	

TECH TIP

For zero dead volume connections, we strongly recommend pre-cut stainless steel tubing . . . 20

NOTE

ID dimensions in mm are converted from nominal inch dimensions.

MORE INFO

About Type 316 stainless steel 114
Maximum working pressure 107
Tubing ID chart: volume per length . . 107

SEE ALSO

Pre-cut SS tubing . . . 20-21
Stainless steel tubing cutter 101
Stainless fittings 36-41

SPECIFICATIONS

PRESSURE RATING

Values shown are minimum; rating varies with ID; (see page 93)

OD	bar	psi
1/16"	315	4600
1/8"	315	4600

TOLERANCES

OD	± 0.05mm (.002")
ID	± 0.05mm (.002")

OPTIONS

Contact us for more info about longer tubing lengths at competitive bulk prices.

Stainless tubing – standard grade

HPLC, GC

- Type 316 stainless steel, welded under inert gas
- Variety of sizes for HPLC and GC applications
- Smooth internal surface
- Soft annealed OD for easy ferrule connections

OD	ID (mm)	Product No.		
		1.5 m	3 m	10 m
1/16"	0.10	JR-T-625-03-M1.5 NEW	JR-T-625-03-M3 NEW	JR-T-625-03-M10 NEW
	0.13	JR-T-625-04-M1.5	JR-T-625-04-M3	JR-T-625-04-M10
	0.18	JR-T-625-05-M1.5	JR-T-625-05-M3	JR-T-625-05-M10
	0.25	JR-T-625-10-M1.5	JR-T-625-10-M3	JR-T-625-10-M10
	0.50	JR-T-625-20-M1.5	JR-T-625-20-M3	JR-T-625-20-M10
	0.75	JR-T-625-30-M1.5	JR-T-625-30-M3	JR-T-625-30-M10
1/8"	1.00	JR-T-625-40-M1.5	JR-T-625-40-M3	JR-T-625-40-M10
1/8"	2.1	JR-T-626-00-M1.5	JR-T-626-00-M3	JR-T-626-00-M10

OD	ID (mm)	per meter Product No.
1/4"	4.65	JR-T-628-00



Stainless steel tubing – pre-cut

- For zero dead volume connections
- Steam-cleaned and ready to use
- Soft annealed OD for easy ferrule connections
- Color bands for quick identification of tubing ID



VICI Jour offers pre-cut 1/32" and 1/16" stainless steel tubing in lengths most commonly required in UHPLC and HPLC systems. The tubes are cut to square, burr-free ends for zero dead volume connections. Colored bands allow quick ID identification. VICI pre-cut tubing is specially cleaned with steam from micro-filtered deionized water, which removes both organic and inorganic contaminants. Longer tubes that cannot be steam-cleaned are cleaned with liquid hexane. Softener-free polyethylene caps are used to prevent any contamination during shipment and storage.

SPECIFICATIONS

PRESSURE RATING

Varies with ID; minimum is 365 bar (5300 psi) (see page 107)

TOLERANCES

Tubing OD	OD and ID (±)
1/32"	0.01 mm
1/16"	± 0.05 mm OD
	± 0.025 mm ID

PRE-CUT TUBING FOR STANDARD HPLC

OD	ID (mm)	Color	NEW		
			50 mm Product No.	100 mm Product No.	130 mm Product No.
1/16"	0.13	Red	JR-T-97005	JR-T-97010	JR-T-97012
	0.18	Yellow	JR-T-97025	JR-T-97030	JR-T-97032
	0.25	Blue	JR-T-97045	JR-T-97055	JR-T-97057
	0.50	Orange	JR-T-97075	JR-T-97080	JR-T-97082
	0.75	Green	JR-T-97095	JR-T-97100	JR-T-97102

OD	ID (mm)	Color	NEW		
			180 mm Product No.	200 mm Product No.	300 mm Product No.
1/16"	0.13	Red	JR-T-97013	JR-T-97015	JR-T-97020
	0.18	Yellow	JR-T-97033	JR-T-97035	JR-T-97040
	0.25	Blue	JR-T-97058	JR-T-97060	JR-T-97065
	0.50	Orange	JR-T-97083	JR-T-97085	JR-T-97090
	0.75	Green	JR-T-97103	JR-T-97105	JR-T-97110

PRE-CUT TUBING FOR MICRO LC **NEW**

Use with 1/32" Nanovolume fittings, page 43.

OD	ID (mm)	Color	NEW		
			50 mm Product No.	100 mm Product No.	130 mm Product No.
1/32" NEW	0.050	Blue	JR-T-91050	JR-T-91100	JR-T-91130
	0.075	Black	JR-T-92050	JR-T-92100	JR-T-92130

OD	ID (mm)	Color	NEW		
			180 mm Product No.	200 mm Product No.	300 mm Product No.
1/32" NEW	0.050	Blue	JR-T-91180	JR-T-91200	JR-T-91300
	0.075	Black	JR-T-92180	JR-T-92200	JR-T-92300

! NOTE

Do not bend Micro LC tubing more than 90° to avoid closure.

t TECH TIP

Contact your local distributor or VICI for custom lengths.

↔ CONVERSIONS

- 50 µm = .002"
- 75 µm = .003"
- 100 µm = .004"
- 125 µm = .005"
- 150 µm = .006"
- 0.13 mm = .005"
- 0.18 mm = .007"
- 0.25 mm = .01"
- 0.50 mm = .02"
- 0.75 mm = .03"

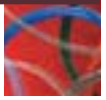

SPECIFICATIONS

PRESSURE RATING

Varies with ID; minimum is 365 bar (5300 psi) (see page 107)

TOLERANCES

OD ±0.05mm (.002")
ID ±0.025mm (.001")

Stainless steel tubing – pre-cut flexible

- Seamless 1/32" tubing with 1/16" laser-welded ends
- For zero dead volume connections
- Steam-cleaned and ready to use
- Soft annealed OD for easy ferrule connections
- Color bands for quick identification

Our flexible pre-cut stainless steel tubing is made of 1/32" premium grade 316 stainless steel tubing with ends laser-welded into 1/16" tubing of the same premium grade.

The tubes are cut to square, burr-free ends for zero dead volume connections. Colored bands allow quick ID identification.

VICI pre-cut tubing is specially cleaned with steam from micro-filtered deionized water, which removes both organic and inorganic contaminants. Longer tubes that cannot be steam-cleaned are cleaned with liquid hexane. Softener-free polyethylene caps are used to prevent any contamination during shipment and storage.

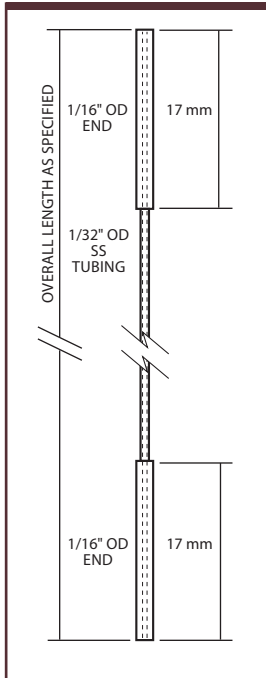

PRE-CUT FLEXIBLE TUBING FOR STANDARD HPLC

OD	ID (mm)	Color	105 mm	<i>NEW</i> 130 mm	150 mm	<i>NEW</i> 180 mm	200 mm
			Product No.	Product No.	Product No.	Product No.	Product No.
1/16"	0.13	Red	JR-T-96005	JR-T-96008	JR-T-96010	JR-T-96013	JR-T-96015
	0.18	Yellow	JR-T-96105	JR-T-96108	JR-T-96110	JR-T-96113	JR-T-96115
	0.25	Blue	JR-T-96205	JR-T-96208	JR-T-96210	JR-T-96213	JR-T-96215
	0.50	Orange	JR-T-96305	JR-T-96308	JR-T-96310	JR-T-96313	JR-T-96315

OD	ID (mm)	Color	280 mm	400 mm	600 mm	700 mm	900 mm
			Product No.	Product No.	Product No.	Product No.	Product No.
1/16"	0.13	Red	JR-T-96020	JR-T-96025	JR-T-96030	JR-T-96035	—
	0.18	Yellow	JR-T-96120	JR-T-96125	JR-T-96130	JR-T-96135	JR-T-96145
	0.25	Blue	JR-T-96220	JR-T-96225	JR-T-96230	JR-T-96235	—
	0.50	Orange	JR-T-96320	JR-T-96325	JR-T-96330	JR-T-96335	—



FITTINGS



HIGH AND LOW PRESSURE



HIGH PRESSURE POLYMERIC FITTINGS page 24-35

High pressure polymeric fittings are useful in applications involving proteins, peptides, and other samples of biological origin where metal systems may interact with samples. Fittings made from PEEK-HT can also be used in UHPLC.



ULTRA-HIGH PRESSURE STAINLESS FITTINGS page 36-41

Our stainless steel fittings are typically compression fittings, in which a ferrule is compressed onto the tube as a nut is tightened. They offer the best reliability in high pressure situations.



NANOVOLUME® HPLC FITTINGS .. page 42-45

With bore sizes of 100 and 150 microns, (.004"-.006"), the minimal transfer volume contributed by Nanovolume® components makes them especially beneficial in applications with flow rates in the $\mu\text{l}/\text{min}$ range, when the transfer volume can be critical.



LOW PRESSURE FITTINGS page 46-55

Low pressure fittings are ideally suited for flow injection analysis, low pressure liquid chromatography, and stream sampling devices. They may be safely used at pressures up to 500 psi and temperatures to 50°C.

MORE INFO

Tools for fittings

Ferrule removal kit ...	103
Tweezer.....	103
ValvTool.....	102
Wrench	103



SPECIFICATIONS

For 1/4" hex-head nuts
MATERIAL
 Polypropylene

COLOR-IT FINGERTIGHT ADAPTERS

- For high and low pressure
- Fit all hex-head PEEK and SS fittings for 1/16" tubing
- Available in six colors for easy solvent line identification

Color-It snap-on fingertight adapters are used with our 1/4" PEEK and stainless hex-head nuts, converting them into color-coded fingertight fittings in an instant. Available in six colors.

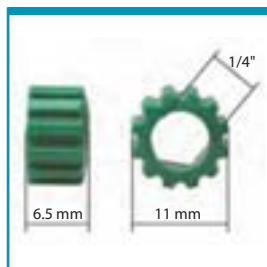

Color	Qty/pkg	Product No.
Blue	5	JR-55010-5
Yellow	5	JR-55011-5
Green	5	JR-55012-5
Black	5	JR-55013-5
White	5	JR-55014-5
Red	5	JR-55015-5
Assorted	12 (2 each)	JR-55016-12



SPECIFICATIONS

For 1/4" hex-head nuts
MATERIAL
 Polypropylene

COLOR-SLEEVE FINGERTIGHT ADAPTERS

- For high and low pressure
- Designed for our PPS fittings for 1/16" tubing
- Available in twelve colors for easy solvent line identification

This adapter is useful for color coding different solvent lines, and turns VICI Jour PPS nuts into fingertight fittings in an instant.

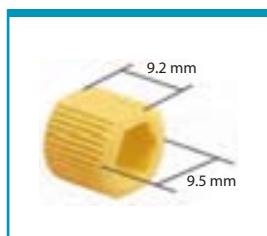

Color	Qty/pkg	Product No.
Natural	5	JR-55080-5
	10	JR-55080-10
White	5	JR-55081-5
	10	JR-55081-10
Dark grey	5	JR-55082-5
	10	JR-55082-10
Black	5	JR-55083-5
	10	JR-55083-10
Lavender	5	JR-55084-5
	10	JR-55084-10
Red	5	JR-55085-5
	10	JR-55085-10
Yellow	5	JR-55086-5
	10	JR-55086-10

Color	Qty/pkg	Product No.
Orange	5	JR-55087-5
	10	JR-55087-10
Brown	5	JR-55088-5
	10	JR-55088-10
Green	5	JR-55089-5
	10	JR-55089-10
Blue	5	JR-55090-5
	10	JR-55090-10
Purple	5	JR-55091-5
	10	JR-55091-10
Assorted	2 each	JR-5508X-24
	2 each	JR-5508X-12



MORE INFO

Hex head nuts
 PEEK 25, 27, 29
 Stainless..... 37
 PPS
 High pressure...25, 31
 Low pressure 47

HIGH PRESSURE FITTINGS



HPLC AND UHPLC, POLYMERIC

Standard high pressure PEEK fittings are rated up to 350 bar (5000 psi) with fingertight nuts, well beyond the burst strength of most PEEK tubing. PEEK-HT™ fittings are rated at about 500 bar when finger-tightened; if they are tightened with a tool, 1,000 bar can be achieved. PEEK-HT also provides the benefit of longer life time; that is, the fittings can be tightened/loosened more often.

All our polymeric fittings for HPLC and UHPLC are manufactured from high quality inert polymers to exacting tolerances.

HIGH PRESSURE POLYMERIC FITTINGS INDEX

ONE-PIECE FITTINGS

PEEK hex-head	
Over 5,000 psi	page 25
Up to 5,000 psi	25
PPS hex-head	25
PEEK fingertight	
Color-coded	26
Natural	26
PEEK no-twist one piece fittings	27

NUTS AND FERRULES

PEEK ferrules, over 5,000 psi	28
Single ferrule connections	28
Double ferrule connections	29
1/4-28 connections	30

PLUGS AND CAPS

PEEK plugs	31
PEEK caps	31

PEEK UNIONS

Unions	32
Bulkhead unions	32
Reducing unions	33

PEEK TEES AND CROSSES

Standard tees and crosses	34
Biocompatible mixing tee	34

PEEK ADAPTERS

PEEK port and Luer adapters	35
-----------------------------	----

! DISCLAIMER

The maximum holding pressure for any type of connections involving tubing and a ferrule varies considerably with the tubing material, the ferrule material, the clearance between tubing OD and ferrule ID, and the shape of the fitting detail.

➔ SEE ALSO

ChromBox kit	105
HPLC parts kit with PEEK and stainless fittings and tubing	
Fingertight adapters	
Color-It	23
Color-Sleeve	23
Nanovolume® high pressure fittings	42-45
PEEK starter kits	104
Tools for fittings	100-103

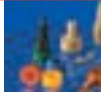

PEEK one-piece hex-head fittings

UHPLC

SPECIFICATIONS

TUBING OD / THREADS

1/32" 6-40
1/16" 10-32

MATERIAL

PEEK-HT

PRESSURE RATING

Fingertight, on stainless steel tubing:

1/32" 625 bar (9,000 psi)
1/16" 700 bar (10,000 psi)

- Made of special PEEK-HT™ for better pressure resistance
- One-piece – no ferrule required
- Biocompatible
- Handy tightening tool included

These fittings are machined from special PEEK material to reach a higher pressure rating than standard PEEK fittings.

Includes a tightening tool (page 103) for easy installation.

	Tubing OD	Thread	Hex size	Length	Product No.
(Package/10)	1/32"	6-40	3/16"	12.0 mm	JR-5525N-10
	1/16"	10-32	1/4"	17.0 mm	JR-5520N-10



PEEK one-piece hex-head fittings

10-32

SPECIFICATIONS

TUBING OD / THREADS

1/16" 10-32

MATERIAL

PEEK

TOLERANCE

±0.05 mm (.002")

PRESSURE RATING

<350 bar (5000 psi)

(Varies with tubing ID and material)

- Fingertight up to 350 bar (5000 psi)
- Excellent chemical and mechanical properties
- One-piece – no ferrule required
- Biocompatible
- For any 10-32 high pressure fitting

PEEK one-piece hex-head fittings are easy to use with the ValvTool or with the Color-It color-coded fingertight adapters. The 10-32 thread will fit virtually all standard high pressure female connections, and will withstand pressures of up to 350 bar (5000 psi). Available in short and long versions.

		Product No.
(Package/5)	Short	JR-55100-5
	Long	JR-55110-5



Short



Long

PPS one-piece hex-head fittings

10-32

SPECIFICATIONS

TUBING OD / THREADS

1/16" 10-32

MATERIAL

Black PPS

(Polyphenylene sulfide)

TOLERANCE

±0.05 mm (.002")

PRESSURE RATING

<350 bar (5000 psi)

(Varies with tubing ID and material)

- Economically-priced alternative to PEEK
- Excellent chemical and mechanical properties
- One-piece – no ferrule required
- Slim design – finger-tight with Color-Sleeve adapter

The VICI Jour PPS one-piece hex-head (fingertight with adapter) fitting offers excellent chemical and pressure resistance.

	Product No.
(Package/5)	JR-58000-5



MORE INFO

About PEEK 113
About PPS. 113
Chemical resistance .. 110

SEE ALSO

1/16" OD tubing for high pressure applications 9-12
PEEK starter kit 104

1/32" and 1/16" tightening tools for PEEK fittings 103



Color-Sleeve adapters for hex-head fittings ... page 23



One-piece fittings • Fingertight

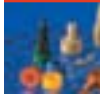

HIGH PRESSURE FITTINGS • POLYMERIC

PEEK and PVDF one-piece fingertight fittings – color-coded

10-32

- PEEK: fingertight up to 350 bar (5000 psi)
- PVDF: fingertight to 180 bar (2600 psi)
- Excellent chemical and mechanical properties
- One-piece – no ferrule required
- Biocompatible

Our PEEK fingertight fittings are available in six colors, for easy identification of tubing lines. They are rated to 350 bar (5000 psi) and can be used in virtually any type of 10-32 thread HPLC fitting detail on the market. PVDF fittings are chemically inert, and suitable for medium pressure applications. They will not constrict soft polymeric tubing as PEEK fingertight fittings sometimes do. Packages of 5.

(Pkg/5)	Material	Color	Product No.
	PEEK	Natural	JR-55020-5
		Black	JR-55021-5
		Red	JR-55022-5
		Yellow	JR-55023-5
		Blue	JR-55024-5
		Green	JR-55025-5

(Pkg/5)	Material	Color	Product No.
	PVDF	Translucent white	JR-55020-PVDF-5 NEW



SPECIFICATIONS

TUBING OD / THREADS
1/16" 10-32

MATERIAL
PEEK

TOLERANCE
±0.05 mm (.002")

PRESSURE RATING

Material	bar	psi
PEEK	<350	5000
PVDF	<180	2600

(Varies with tubing ID and material)

PEEK one-piece fingertight fittings

10-32

- Two new fittings are made of reinforced glass fiber (GF) PEEK.
 - Fingertight up to 350 bar (5000 psi)
 - One-piece – no ferrule required
 - Biocompatible
- Sold in packages of 5.

(Package/5)	Standard	Natural PEEK			Product No.
			12.0 mm	22.0 mm	JR-5502-5
	Short	Natural PEEK	12.0 mm	17.1 mm	JR-5504-5
	Long	Natural PEEK	12.0 mm	25.1 mm	JR-5507-5
	Narrow hex-head/fingertight	Natural PEEK	1/4"	28.1 mm	JR-5508-5
	Standard	Reinforced GF PEEK	9.15 mm	20.8 mm	JR-5513-5 NEW
	Narrow hexhead/fingertight	Reinforced GF PEEK	1/4"	28.1 mm	JR-5518-5 NEW

SPECIFICATIONS

TUBING OD / THREADS
1/16" 10-32

MATERIAL
PEEK

TOLERANCE
±0.05 mm (.002")

PRESSURE RATING

<350 bar (5000 psi)
(Varies with tubing ID and material)

TECH TIP

Coloration pigments are carefully chosen so as to contain no heavy metals or hazardous chemicals.

TECH TIP

Color-It fingertight adapters may be used with 1/4" hex-head fittings, such as JR-5518, converting them into color-coded fingertight fittings... page 23

MORE INFO

About PEEK 113
About PVDF 113
Chemical resistance .. 110



PEEK-HT™ one-piece fittings **NEW**

10-32

SPECIFICATIONS

TUBING OD / THREADS
1/16" 10-32

MATERIAL
PEEK-HT

TOLERANCE
±0.05 mm (.002")

PRESSURE RATING

Tightening	bar	psi
Fingertight	<500	7250
With tool	<1000	14500

(Varies with tubing ID and material)

When used as fingertight fittings, our PEEK-HT fittings hold pressures up to 500 bars (7250 psi). Pressures up to 1000 bars (14,500 psi) can be accomplished with a tightening tool.



For tightening tool, use either a ValvTool (JR-800, page 102) or an open end wrench (JR-804, page 103.)

Sold in packages of 5.

(Package/5)	Product No.
	JR-55031-5



PEEK no-twist "one-piece" fittings

10-32

SPECIFICATIONS

TUBING OD / THREADS
1/16" 10-32

MATERIAL
Nut: PEEK
Ferrule: PEEK

PRESSURE RATING
<350 bar (5000 psi)
(Varies with tubing ID and material)

OPTIONS

OPTIONAL FERRULE MATERIALS
FEP, PFA, glass-filled PEEK, PCTFE, glass-filled PTFE, and PTFE.
Contact us for availability.
Some 1/32" versions are available. Call for details.





- Snap-in ferrule rotates freely
- Choice of ferrule materials
- Choice of fitting lengths

No-twist fittings offer the convenience of a one-piece fitting while solving a problem inherent to such designs. In other one-piece designs, the ferrule rotates against the fitting detail, creating particulates. The no twist design has a separate ferrule that snaps into the nut, so it's attached but still free to avoid rotation during tightening.

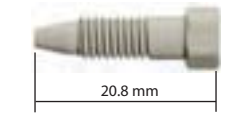

Since the ferrule is not machined onto the nut, it can be made from a different material. We offer several PEEK nuts, with ferrules of PEEK or one of the optional materials listed at left.

Sold in packages of 5.

(Package/5)	Tubing OD			PEEK ferrule Product No.
	1/16"	Fingertight		JR-ZNF1FPK-5
		Hex, short		JR-ZNF1PK-5
		Hex, medium		JR-MZNF1PK-5
		Hex, long		JR-LZNF1PK-5
		Replacement ferrules		JR-ZNF1PK-F-5

SEE ALSO

1/16" OD tubing for high pressure applications . . .page 9-12
PEEK starter kit 104
ValvTool for tightening hex-head fittings . . . 102
Color-It fingertight adapters. 23





PEEK ferrules

UHPLC

- Biocompatible 1/16" ferrule for ultra-high pressures
- Alternative to titanium ferrules in applications with titanium valves
- Excellent in combination with stainless nuts (see page 37)

	Product No.
(Package/5)	JR-5010N-5



SPECIFICATIONS

TUBING OD / THREADS
1/16" 10-32

MATERIAL
PEEK

PRESSURE RATING
On SS tubing with SS nut:
650 bar (9400 psi)

PEEK nuts with single ferrules

- Reuseable nut, replaceable ferrule
- For 1/32", 1/16", and 1/8" tubing
- Suitable for pressures to 280 bar (4000 psi)





Fingertight nuts have a knurled surface designed to allow sufficient sealing force to be applied to the ferrule without wrenches. Hex style nuts allow wrench tightening; however, since they are polymeric, they can break, and are recommended for use only when space is limited and your fingers will not fit.

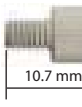

SPECIFICATIONS

MATERIAL
PEEK

PRESSURE RATING
<280 bar (4000 psi)
(Varies with tubing ID and material)

(Pkg/5)		Tubing		Product No.		
		OD	Thread			
	Single ferrules	1/32"		JR-ZF.5PK-5		
		1/16"		JR-5003-5		
		1/8"		JR-ZF2PK-5		
	Nuts	Fingertight	1/32" 6-40	 6.4 mm (6.35 mm)	 10.7 mm	JR-ZN.5FPK-5
			1/16" 10-32	 10 mm	 17.5 mm	JR-5570-5
		Hex-head	1/8" 5/16-24	 9.5 mm	 16 mm	JR-ZN2PK-5

➔ MORE INFO

About PEEK 113
Chemical resistance .. 110

➔ SEE ALSO

1/16" OD tubing for high pressure applications 9-12
PEEK starter kit 104
PEEK tubing 9-12
Stainless steel nuts ... 37
ValvTool for tightening hex-head fittings ... 102
Color-It fingertight adapters..... 23





PEEK nuts with double ferrules

10-32

SPECIFICATIONS

TUBING OD / THREADS
1/16" 10-32







MATERIAL
PEEK

PRESSURE RATING
<420 bar (6000 psi)
(Varies with tubing ID and material)

- High pressure rating - up to 420 bar (6000 psi)
- Ideal for 1/16" PEEK tubing
- Fit any 10-32 fitting

These nuts are for use with VICI Jour double ferrules, which grip the tubing twice for added stability. The fingertight version may be hand-tightened for operation at up to 420 bar (6000 psi). The hex-head version can be used for connections that are difficult to reach, or are closely spaced. The fittings work in virtually any female 1/16" fitting.

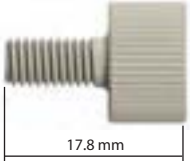

		Tubing OD					Product No.
(Package/5)	Double ferrule	1/16"					JR-5004-5
	Nuts	1/16"	Hex-head	Short			JR-5511-5
				Long			JR-5510-5
		Fingertight			R-5580-5		



HIGH PRESSURE FITTINGS • POLYMERIC

Nut, ferrule, and bushing

1/4-28

- High pressure rating – up to 490 bar (7000 psi) with 1/16" tubing
- For 1/4-28 connections
- Available for 1/32" and 1/16" tubing

This combination of PPS nut, PEEK ferrule, and stainless steel bushing allows a high pressure connection in a 1/4-28 flat-bottomed fitting detail.

Sold in packages of 10.

Order nuts and bushing/ferrules separately.



SPECIFICATIONS

TUBING OD / THREADS

1/32"	1/4-28
1/16"	1/4-28

MATERIALS

Nut	PPS
Ferrule	PEEK
Bushing	SS

PRESSURE RATING

OD	bar	psi
1/32"	175	2500
1/16"	490	7000

(Varies with tubing ID and material)

		Tubing OD		Product No.
(Package/10)	PPS hex-head nut	1/32" or 1/16"		JR-55050-10
	Bushing and ferrule	1/32"		JR-FPKBSS.5-10
		1/16"		JR-FPKBSS1-10

→ LOW PRESSURE 1/4-28 NUTS AND FERRULES

1/4-28 PPS hex-head nuts are available with three different sealing designs for flangeless and flanged fittings 47



t TECH TIP

To make up high pressure connection with nut, ferrule, and bushing, first slide the nut on the tubing, then the bushing, and then the PEEK ferrule as shown in the product photo.

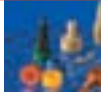

PEEK plugs and caps



SPECIFICATIONS

MATERIAL
PEEK

PRESSURE RATING
<350 bar (5000 psi)
(Varies with tubing material)

- For plugging ports and capping solvent lines
- Available in all common thread sizes

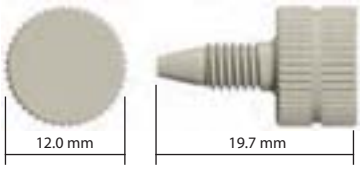
Sold individually.

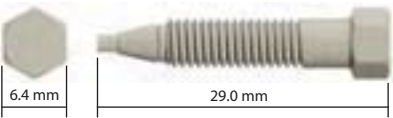
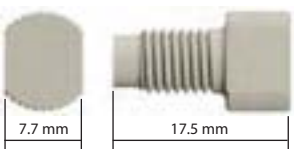
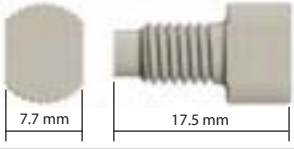
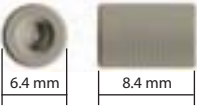
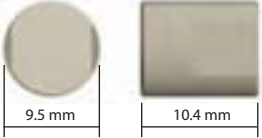
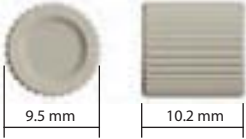
	Threads		Product No.
Plugs	6-40		JR-ZP.5FPK
	10-32		JR-408
			JR-ZP1FPK
			JR-MZP1PK
		JR-LZP1PK	
1/4-28		JR-409	
M6		JR-410	
Caps	6-40		JR-ZC.5FPK
	10-32		JR-ZC1PK
	1/4-28		JR-CCPK-1

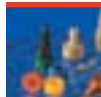

PEEK unions

10-32

- Easy connection of transfer/solvent lines
- Low dead volume
- Completely inert and biocompatible



VICI Jour PEEK unions are usable with most common organic and inorganic HPLC solvents without risking corrosion, metal contamination, or protein degradation that might occur with stainless steel. Small diameter bores are used to ensure low dead volume connections. These unions have the standardized Valco fitting details with smooth transition of the taper into the threaded part. Connections to these PEEK unions can be made with any 10-32 fitting that uses polymeric ferrules. PEEK unions are available in body-only versions as well as complete with our PEEK one-piece fingertight fittings ready to connect to any 1/16" OD tubing.

SPECIFICATIONS

TUBING OD
1/16"

MATERIAL
PEEK

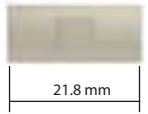
PRESSURE RATING
<350 bar (5000 psi)
(Varies with tubing ID and material)

	Bore (mm)		Qty/pkg	Product No.
Union with fittings	0.25		1	JR-1061
	0.50		1	JR-1066
	0.75		1	JR-1067
Body only	0.25		1	JR-061
	0.50		1	JR-066
	0.75		1	JR-067
Replacement fittings				
PEEK 1/16" one-piece fingertight fittings, 10-32, black			5	JR-55021-5

PEEK bulkhead unions

10-32

- Designed for panel mounting
- Easy connection of transfer/solvent lines
- Low dead volume
- Completely inert and biocompatible

Bulkhead unions are designed to be mounted through an instrument panel or on a bracket. Typically the mounting nut goes inside the instrument, so that the long threaded portion will be out of sight.

Bulkhead unions require a minimum 10 mm panel hole, 9 mm maximum thickness.



Includes fittings.

SPECIFICATIONS

TUBING OD / THREADS
1/16" 10-32

MATERIAL
PEEK

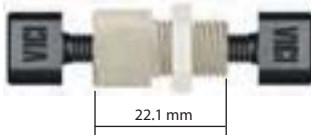
PRESSURE RATING
<350 bar (5000 psi)
(Varies with tubing ID and material)

	Bore (mm)		Qty/pkg	Product No.
Bulkhead union with fittings	0.25		1	JR-ZBU1CFPK
	0.50		1	JR-ZBU1MFPK
	0.75		1	JR-ZBU1FPK
Replacement fittings				
PEEK 1/16" one-piece fingertight fittings, 10-32, black			5	JR-55021-5
JAM-Nut replacement mounting nut for bulkhead fittings			1	JR-CBN

SEE ALSO

Low pressure PEEK 1/4-28 unions. 50
PEEK one-piece fingertight fittings 25-27

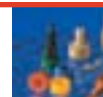

PEEK reducing unions

SPECIFICATIONS

TUBING OD / THREADS

1/32"	6-40
1/16"	10-32
1/8"	5/16-24

MATERIAL

PEEK







PRESSURE RATING

<350 bar (5000 psi)
(Varies with tubing ID and material)

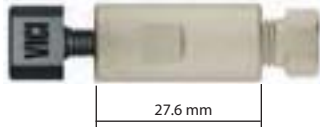
- Connects 1/16" to 1/32" tubing, or 1/8" to 1/16" tubing
- Easy connection of transfer/solvent lines
- Completely inert and biocompatible

VICI Jour PEEK reducing unions are usable with most common organic and inorganic HPLC solvents without risking corrosion, metal contamination, or protein degradation that might occur with stainless steel. These reducing unions have the standardized Valco fitting details with smooth transition of the taper into the threaded part.

Includes fittings.

Tubing OD	Bore (mm)		Qty/pkg	Product No.
1/16" to 1/32"	0.25		1	JR-ZRU1.5FPK
1/8" to 1/16"	0.75		1	JR-ZRU21FPK
PEEK replacement fittings				
For 1/16" to 1/32" reducing unions				
1/16"	One-piece fitting, black		5	JR-55021-5
1/32"	Fingertight nut		1	JR-ZN.5FPK
1/32"	Ferrule		1	JR-ZF.5PK
For 1/8" to 1/16" reducing unions				
1/8"	Hex-head PEEK nut		5	JR-ZN2PK-5
1/8"	PEEK ferrule		5	JR-ZF2PK-5
1/16"	One-piece fitting, black		5	JR-55021-5

SEE ALSO

Low pressure PEEK
1/4-28 reducing
unions 51



PEEK tees and crosses

10-32

- Easy connection of transfer/solvent lines
- Low dead volume
- Completely inert and biocompatible

The 100% PEEK flowpath makes VICI Jour PEEK tees and crosses usable with most common organic and inorganic HPLC solvents without the risk of corrosion, metal contamination, or protein degradation that might occur with stainless steel.

Small diameter through-holes are used to ensure low dead volume connections. These unions have the standardized Valco fitting details with smooth transition of the taper into the threaded part. Connections to these PEEK tees and crosses can be made with any 10-32 fitting that uses polymeric ferrules.

PEEK tees and crosses are available in body-only versions as well as complete with our PEEK one-piece fingertight fittings ready to connect to any 1/16" OD tubing.





SPECIFICATIONS

TUBING OD / THREADS
1/16" 10-32

MATERIAL
PEEK

BODY SIZE
25.0 mm OD
12.0 mm thick

PRESSURE RATING
<350 bar (5000 psi)
(Varies with tubing ID and material)

	Bore (mm)	Qty/pkg	With fittings Product No.	Body only Product No.	
	0.25	1	JR-1030	JR-2030	
	0.50	1	JR-1032	JR-2032	
	0.75	1	JR-1033	JR-2033	
	0.25	1	JR-1040	JR-2040	
	0.50	1	JR-1042	JR-2042	
	0.75	1	JR-1043	JR-2043	
Replacement fittings					
PEEK 1/16" one-piece fingertight fittings, 10-32, black		5	JR-55021-5		

t TECH TIP

Use our color-coded one-piece fingertight fittings for easy solvent line identification. 26



➔ MORE INFO

About PEEK 113
Chemical resistance . . 110

➔ SEE ALSO

Low pressure 1/4-28 tees and crosses 52
Low pressure 1/4-28 mixing tees 53

Biocompatible mixing tee

10-32

- High pressure gradient mixing
- Completely biocompatible
- Post column reactions
- Built-in protein-friendly titanium filter, 10 μm

A unique, more thorough mixing results from the turbulence generated by the introduction angle of the solvents as well as by the flow through our titanium filter element. The biocompatible tee can be used for high pressure gradient mixing as well as for post column reactions.

	Product No.
Mixing tee with fittings	JR-9000-0670

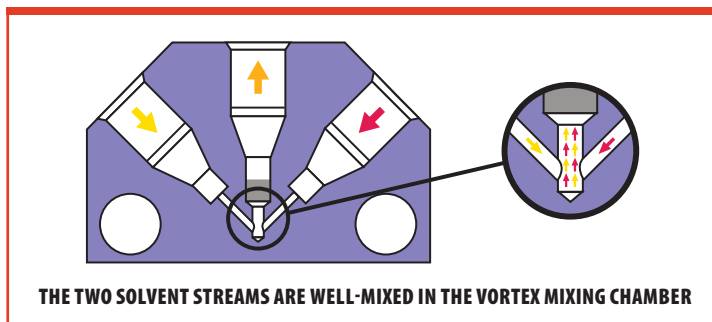

SPECIFICATIONS

TUBING OD / THREADS
1/16" 10-32

MATERIAL
PEEK

PRESSURE RATING
<350 bar (5000 psi)
(Varies with tubing ID and material)



PEEK adapters

SPECIFICATIONS

MATERIAL

PEEK

BORE

0.40 mm

PRESSURE RATING

M6 <70 bar (1000 psi)

1/4-28 <70 bar (1000 psi)

Luer <35 bar (500 psi)

(Varies with tubing ID and material)

- Connect various combinations of thread types, male and female
- Includes male and female Luer adapters
- Low dead volume
- For any 10-32 high pressure fitting

We offer male and female Luer adapters as well as adapters to connect standard LC fittings to standard LC ports. The 100% PEEK flowpath makes VICI Jour PEEK adapters usable with most common organic and inorganic HPLC solvents without risking corrosion, metal contamination, or protein degradation that might occur with stainless steel.

Sold individually.

Description	Product No.	Description	Product No.
1/4-28 female to	10-32 male	JR-0612	10-32 male to
	10-32 female	JR-062	
	M6 male	JR-0622	JR-0691 NEW
	Luer female	JR-0625	Waters female to
	Luer male	JR-0626	10-32 male
10-32 female to	1/4-28 male	JR-0617	M6 female to
	M6 female (Pharmacia*)	JR-5595	10-32 male
	Luer female	JR-0623	JR-5505
		Female Luer to	1/4-28
			JR-CFLAPK
		Male Luer to	10-32
			JR-ZUFLPK
			1/4-28
			JR-CMLAPK

1/4-28 FEMALE TO:

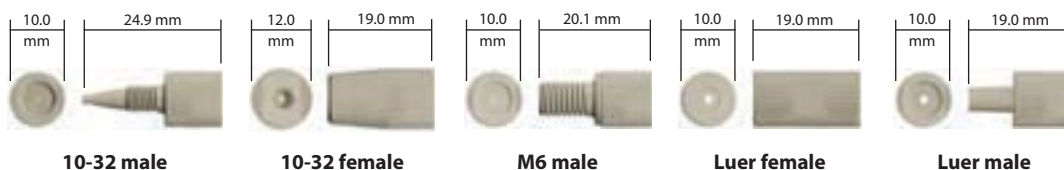

10-32 FEMALE TO:

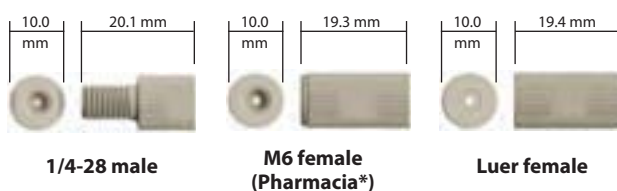

10-32 MALE TO:



WATERS FEMALE TO:

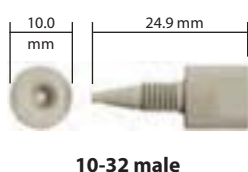

M6 FEMALE TO:



FEMALE LUER TO:

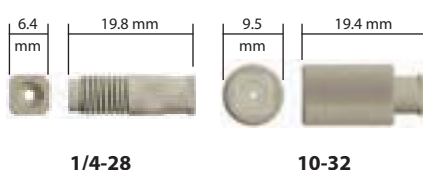

MALE LUER TO:

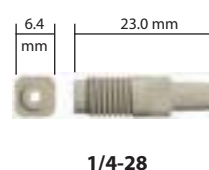

* Pharmacia is a division of GE Healthcare.

ULTRA-HIGH PRESSURE FITTINGS



STAINLESS STEEL

Our stainless steel fittings are typically compression fittings, in which a ferrule is compressed onto the tube as a nut is tightened. They offer the best reliability in high and ultra-high pressure situations.

ULTRA-HIGH PRESSURE STAINLESS FITTINGS INDEX

NUTS

Valco nutspage 37

Valco nuts are available for 1/32", 1/16", and 1/8" tubing, in several lengths.

Rheodyne® compatible nuts 37

These nuts are sized for 1/16" tubing, and come in three lengths.

FERRULES

Valco 38

Rheodyne compatible..... 38

PLUGS AND CAPS

Plugs 38

Caps..... 39

TEES AND CROSSES

Tees 39

Crosses 39

UNIONS AND REDUCING UNIONS

Unions..... 40

Reducing unions

Imperial 40

Imperial to metric 41

! DISCLAIMER

The maximum holding pressure for any type of connections involving tubing and a ferrule varies considerably with the tubing material, the ferrule material, the clearance between tubing OD and ferrule ID, and the shape of the fitting detail.

➔ MORE INFO

ChromBox kit..... 105

HPLC parts kit with PEEK and stainless fittings and tubing

Fingertight adapters

Color-It 23

Color-Sleeve..... 23

Nanovolume® high pressure fittings . . 42-45

Stainless starter kits . . 104

Tools for fittings . 102-103



UHPLC

Valco® stainless nuts

SPECIFICATIONS

TUBING OD / THREADS

1/32"	6-40
1/16"	10-32
1/8"	5/16-24

MATERIAL

Type 303 SS

PRESSURE RATING

With premium SS tubing
and ZF1S6 ferrule:
1375 bar (20,000 psi)

- Excellent fit to Valco fitting details
- Different lengths available
- For 1/32", 1/16", and 1/8" OD tubing

These nuts are for use with all standard Valco internal fittings and most valves. They may be used with fittings from other manufacturers as well. The medium and long types are ideal for metal Valco and Cheminert valves with more than 8 ports, or where the fitting head may be otherwise inaccessible.

	Tubing OD	Length	Product No.
(Package/5)	1/32"	Standard	JR-ZN.5-5
		1/16"	Standard
	1/16"	Medium	JR-MZN1-5
		Long	JR-LZN1-5
1/8"	Standard	JR-ZN2-5	

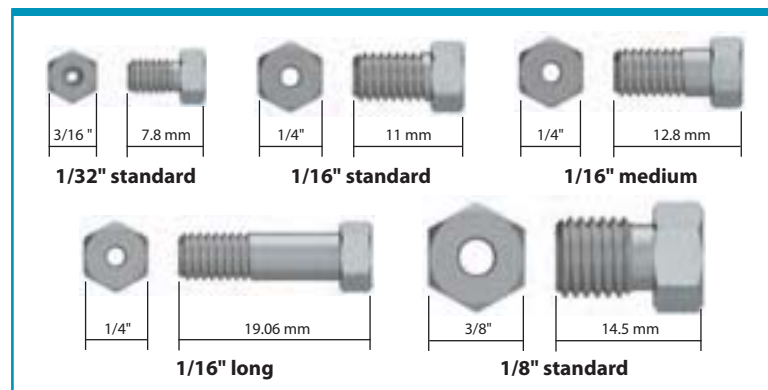

Rheodyne® compatible stainless nuts

UHPLC

SPECIFICATIONS

TUBING OD / THREADS

1/16" 10-32

MATERIAL

Type 316 SS

PRESSURE RATING

<500 bar (7,250 psi)
(Varies with tubing ID and
material)

- Excellent fit to Rheodyne fitting details
- Different lengths available
- For 1/16" OD tubing

These nuts are for use with metal Rheodyne valves. Three different length nuts are available, in order to accommodate any possible connecting situation. The standard nut is suitable for easily accessible connections (couplers, detectors, columns, etc.) For very tight and difficult to reach areas, we recommend the long and extra long nut.

	Tubing OD	Length	Product No.
(Package/5)	1/16"	Short	JR-56-5
		Long head	JR-57-5
		Extra long	JR-58-5

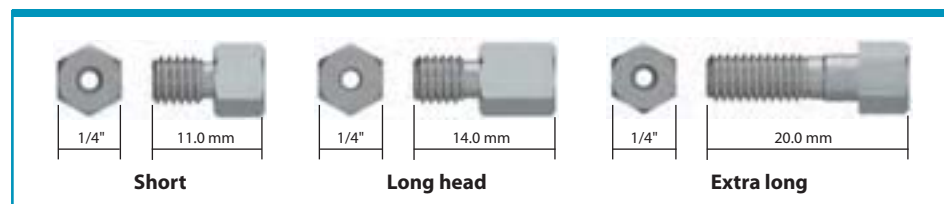

TECH TIP

Using nuts with different lengths will create more space, for better wrench access.

MORE INFO

About stainless steel . . . 114

SEE ALSO

Ferrules	Stainless steel	ValvTool	Color-It fingertight
Rheodyne 38	starter kit 104	for tightening	adapters 23
Valco 38	Stainless tubing . . 19-21	hex-head fittings . 102	



Valco® stainless ferrules

UHPLC

- Excellent fit to Valco fitting details
- For 1/32", 1/16", and 1/8" OD tubing

These ferrules are for use with all standard Valco internal fittings and most valves, and with those of most other manufacturers as well. Valco metal ferrules cut a ring near the end of the tube, preventing tube release at high pressures without significantly deforming and restricting the tube interior. (However, if the hardness of the tubing is equal to or greater than that of the ferrule, deformation of the tube rather than a cut ring is likely.)

	Tubing OD		Product No.	
(Package/5)	1/32"		JR-ZF.5S6-5	
	1/16"		JR-ZF1S6-5	
	1/8"		JR-ZF2S6-5	

SPECIFICATIONS

TUBING OD
For 1/32", 1/16", and 1/8" OD tubing

MATERIAL
Type 316 SS

PRESSURE RATING
1375 bar (20,000 psi)
(Varies with tubing ID and material)

Rheodyne® compatible stainless ferrules

- Excellent fit to Rheodyne fitting details
- For 1/16" OD tubing
- For use with metal Rheodyne valves.

	Tubing OD		Product No.	
(Package/5)	1/16"	Standard ferrule		JR-59-5
		2-step Rheodyne-type ferrule		JR-60-5

SPECIFICATIONS

TUBING OD
For 1/16" OD tubing

MATERIAL
Type 316 SS

PRESSURE RATING
<500 bar (7,250 psi)
(Varies with tubing ID and material)

Stainless steel plugs

UHPLC

Use a plug to close off an unused port in a valve, manifold, or HPLC column. The standard stainless plug consists of a zero volume nut with a ferrule made up on a piece of solid rod.

	Tubing OD	Product No.
(Sold individually)	1/32"	JR-ZP.5
	1/16"	JR-ZP1
	1/8"	JR-ZP2

SPECIFICATIONS

TUBING OD / THREADS

1/32"	6-40
1/16"	10-32
1/8"	5/16-24

MATERIAL

1/32"	Type 303 SS
1/16"	Type 316 SS
1/8"	Type 303 SS

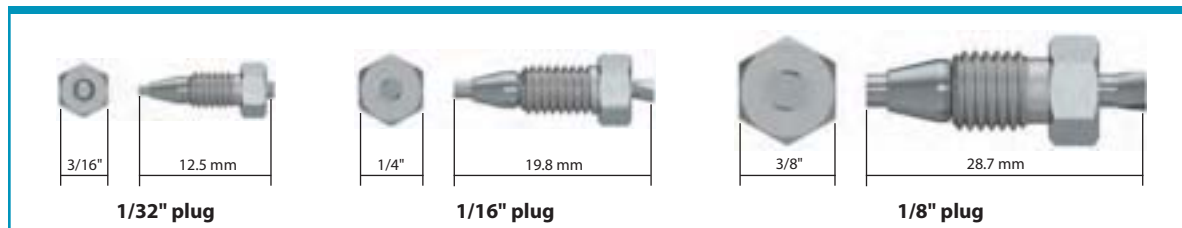

SEE ALSO

- UHPLC PEEK ferrules . . . 28
- Open end wrench . . . 103
- Stainless steel starter kit 104
- ValTool for tightening hex-head fittings . . . 102

**SPECIFICATIONS****TUBING OD / THREADS**

1/32"	6-40
1/16"	10-32
1/8"	5/16-24

MATERIAL

Type 303 SS

Stainless steel caps**UHPLC**

Use a cap to close off a tube with a ferrule and internal nut already made up. A cap is essentially a piece of hex stock with a zero volume fitting detail machined into it, but with no through-hole.

	Tubing OD	Product No.
(Sold individually)	1/32"	JR-ZC.5
	1/16"	JR-ZC1
	1/8"	JR-ZC2

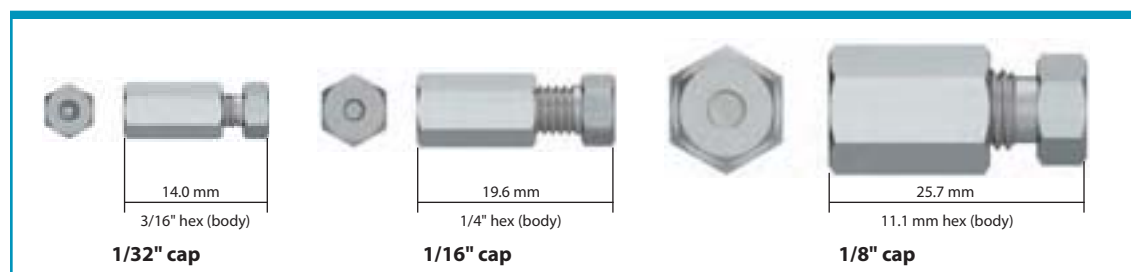
**SPECIFICATIONS****TUBING OD**

For 1/16" OD tubing

BODY DIMENSIONS

23.4 mm OD x 12.7 mm thick

MATERIAL

Body Type 316 SS

Nuts Type 303 SS

Ferrules Type 316 SS

PRESSURE RATING

1375 bar (20,000 psi)

(Varies with tubing ID and material)

TEES AND CROSSES

- Easy connection of solvent lines
- Low dead volume
- For 1/16" OD tubing

VICI stainless steel tees and crosses are for joining solvent lines. They are precision machined with a focus on the concentricity of the bore as well as on the finish of the surfaces to create leak-free connections.

These tees and crosses have internal threads, which we recommend for most applications. Internal threads make stronger connections and internal fitting details provide the lowest dead volume for high performance instrumentation.

Stainless tees**UHPLC**

VICI stainless steel tees join three 1/16" solvent lines.

Three nuts and ferrules are included with each tee.

	Bore (mm)	Qty/pkg	Product No.
1/16" tee	0.25	1	JR-ZT1C
	0.50	1	JR-ZT1M
	0.75	1	JR-ZT1
Replacement nut		5	JR-ZN1-5
Replacement ferrule		5	JR-ZF1S6-5

**Stainless crosses****UHPLC**

VICI stainless steel crosses join four 1/16" solvent lines.

Four nuts and ferrules are included with each tee.

	Bore (mm)	Qty/pkg	Product No.
1/16" cross	0.25	1	JR-ZX1C
	0.50	1	JR-ZX1M
	0.75	1	JR-ZX1
Replacement nut		5	JR-ZN1-5
Replacement ferrule		5	JR-ZF1S6-5





UNIONS AND REDUCING UNIONS

- Easy connection of solvent lines
- Low dead volume

VICI stainless steel unions and reducing unions are precision machined with a focus on the concentricity of the bore as well as on the finish of the surfaces to give an absolute leak-free connection.

These unions have internal threads, which we recommend for most applications. Internal threads make stronger connections and internal fitting details provide the lowest dead volume for high performance instrumentation.

Stainless unions

UHPLC

- Choice of four bore sizes
- For 1/16" OD tubing

VICI stainless steel unions join two pieces of 1/16" OD metal tubing.

Two nuts and ferrules ship with each union.

	Bore (mm)	Qty/pkg	Product No.
1/16" union	0.15	1	JR-ZU1XCS6
	0.25	1	JR-ZU1CS6
	0.50	1	JR-ZU1MS6
	0.75	1	JR-ZU1S6
Replacement nut		5	JR-ZN1-5
Replacement ferrule		5	JR-ZF1S6-5

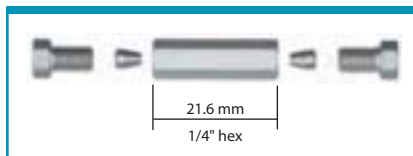

SPECIFICATIONS

TUBING OD

For 1/16" OD tubing

MATERIAL

Body Type 316 SS
Nuts Type 303 SS
Ferrules Type 316 SS

PRESSURE RATING

1375 bar (20,000 psi)
(Varies with tubing ID and material)

Stainless reducing unions

IMPERIAL

UHPLC

These reducing unions join 1/16" OD to 1/8" OD tubing.

Two nuts and ferrules ship with each union.

	Size	Qty/pkg	Product No.
Reducing union	1/8" to 1/16"	1	JR-ZRU21
Replacement nut	1/8"	5	JR-ZN2-5
	1/16"	5	JR-ZN1-5
Replacement ferrule	1/8"	5	JR-ZF2S6-5
	1/16"	5	JR-ZF1S6-5

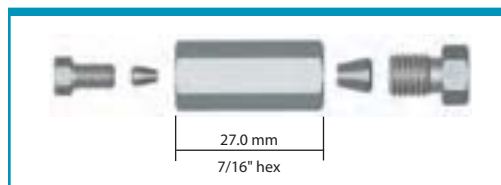

SPECIFICATIONS

TUBING OD

For joining 1/8" to 1/16" OD tubing

MATERIAL

Body Type 316 SS
Nuts Type 303 SS
Ferrules Type 316 SS

PRESSURE RATING

1375 bar (20,000 psi)
(Varies with tubing ID and material)

SEE ALSO

Nanovolume® high pressure fittings . . . 42-45
Stainless starter kit . . . 104
HPLC parts kit with stainless fittings and tubing
ChromBox kit. 105
HPLC parts kit with PEEK and stainless fittings and tubing



Stainless reducing unions

IMPERIAL TO METRIC

UHPLC

SPECIFICATIONS

TUBE REDUCING OD

1/32" to 1.0 mm
1/16" to 2.0 mm
1/8" to 3.0 mm

MATERIAL

Body Type 303 SS
Nuts Type 303 SS
Ferrules Type 316 SS

PRESSURE RATING

1375 bar (20,000 psi)
(Varies with tubing ID and material)

- Ultra-high pressure
- For 1 mm, 2 mm, and 3 mm OD tubing



With these reducing unions, metric tubing can be connected to imperial fittings, valves, and chromatographic systems. The unions are manufactured from Type 303 stainless steel.

For easy identification, the metric end is marked by a groove.

Two nuts and ferrules ship with each reducing union.

	Tubing OD	Bore (mm)	Threads	Qty/pkg	Product No.
Reducing union	1/32" to 1.0 mm	0.25	6-40 to 10-32	1	JR-096
	1/16" to 2.0 mm	0.75	10-32	1	JR-082
	1/8" to 3.0 mm	0.75	5/16-24	1	JR-086

	Tubing OD	Threads	Qty/pkg	Product No.
Replacement nut	1/32"	6-40	5	JR-ZN.5-5
	1/16"	10-32	5	JR-ZN1-5
	1/8"	5/16-24	5	JR-ZN2-5
	for 1.0 mm	10-32	5	JR-ZN1-5
	for 2.0 mm	10-32	5	JR-80-5
	for 3.0 mm	5/16-24	5	JR-ZN2-5

	Tubing OD	Qty/pkg	Product No.
Replacement ferrule	1/32"	5	JR-ZF.5S6-5
	1/16"	5	JR-ZF1S6-5
	1/8"	5	JR-ZF2S6-5
	1.0 mm	5	JR-097-5
	2.0 mm	5	JR-083-5
	3.0 mm	5	JR-087-5

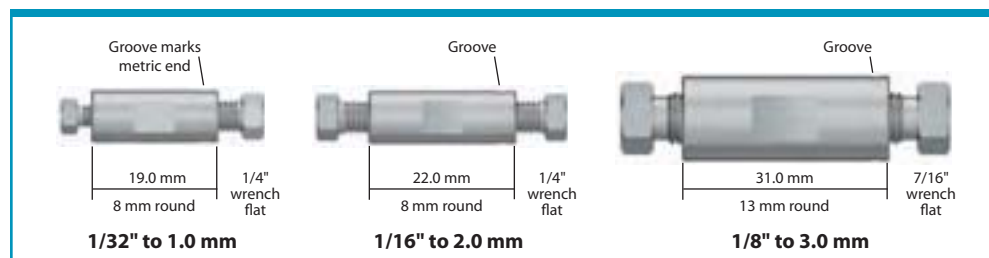

i WRENCH SIZE FOR BODY FLAT

Wrench Reducing size union P/N

1/4" 1/32" to 1.0 mm JR-096
1/4" 1/16" to 2.0 mm JR-082
7/16" 1/8" to 3.0 mm JR-086

NANOVOLUME® FITTINGS



HIGH PRESSURE FITTINGS • FOR 360 MICRON AND 1/32" TUBING

VICI Nanovolume® fittings generally have bore sizes of 100-150 μm (.004" - .006"), ranging down to 50 μm (.002"). The minimal transfer volume contributed by Nanovolume® components makes them especially beneficial in applications with flow rates in the $\mu\text{l}/\text{min}$ range, when the transfer volume can be critical.

HIGH PRESSURE NANOVOLUME® FITTINGS INDEX

1/32" NANOVOLUME® FITTINGS

Nuts, ferrules, unions, and reducing unions 43

1/32" fittings, with 100 or 150 μm bore, are ideal for high resolution capillary chromatography. Rated at 5,000 psi with fingertight nuts, they will remain leak-tight well beyond the burst strength of most PEEK tubing. These fittings are machined from high quality inert polymers to the same exacting tolerances as our popular Valco zero dead volume fittings, and the taper angle and detail design conform to the industry standard established by the Valco line.

360 MICRON NANOVOLUME® FITTINGS

For PEEK or FS tubing, <10K psi 44

For fused silica tubing, 10K psi 45

For metal tubing, <20K psi 45

These high pressure fittings permit direct connection of 360 μm OD fused silica, PEEK, stainless, or electroformed nickel tubing without the use of liners. The ferrule snaps into the nut so that the fitting is "one-piece", but the ferrule remains free to rotate as the nut is tightened so that the tube doesn't twist. Because of the compact size and fine 2-56 threads, a leak-free connection that seals at pressures in excess of 20,000 psi can be easily formed with the available manual tool.

➔ MORE INFO

360 μm OD capillaries	
Fused silica	18
Stainless	19
1/32" OD capillaries	
Stainless	19-20

! DISCLAIMER

The maximum holding pressure for any type of connections involving tubing and a ferrule varies considerably with the tubing material, the ferrule material, the clearance between tubing OD and ferrule ID, and the shape of the fitting detail.



NANO VOLUME FITTINGS FOR 1/32" TUBING

- 100 and 150 µm bores available
- Nuts, ferrules, and unions
- For PEEK tubing

VICI Nanovolume® fittings are designed for capillary LC, used in HTS techniques, proteomics, genomics, and other newer developments in industrial research requiring small sample size for reduction of analysis time.

VICI Nanovolume connectors include our one-piece fingertight fittings for 1/32" OD tubing, featuring our patented* collapsible ferrule. PEEK ferrules for use with our external nuts also feature the collapsible, grooved design. To avoid potential confusion, all fittings utilizing the Cheminert collapsible ferrule are made of black PEEK; fittings with a standard Valco ZDV fitting detail are natural PEEK.

*U.S. patent no. 6,575,501.

SPECIFICATIONS

TUBING OD / THREADS

For 1/32" OD PEEK

Nut/ferrule	6-40
External nut	
1/32"	8-36
1/16"	10-32

MATERIAL

PEEK

PRESSURE RATING

<350 bar (5,000 psi)
(Varies with tubing ID and material)

TOLERANCES

±0.05mm (.002")

Nanovolume® fittings

FOR 1/32" TUBING

The internal nut includes a collapsible ferrule as an integral part of the fitting; the external nut must be used with the separate ferrule listed below.

	Tubing OD	Product No.
One-piece nut/ferrule	1/32"	JR-C-NNFFPK
External nut	1/32"	JR-C-EN.5FPKB
	1/16"	JR-EN1FPKB
Ferrule, collapsible	1/32"	JR-ZGF.5PK
	1/16"	JR-ZGF1PK

	Bore size: Tubing OD	100 micron	150 micron
		Product No.	Product No.
Union (external to internal)	1/32"	JR-C-NEU.5XFPK	JR-C-NEU.5FPK
Reducing union	1/16" to 1/32"	—	JR-C-NERU1FPK

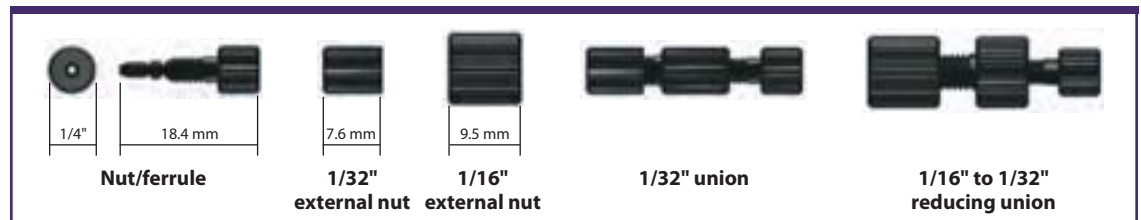

Liners for 1/32" connectors

FOR USE WITH FUSED SILICA TUBING

Use these natural PEEK liners to adapt 1/32" connectors to the most common sizes of fused silica tubing.

The 27 mm liners are for internal nuts with collapsible ferrules (JR-C-NNFFPK or JR-C-NNFLFPK). 10 mm liners are for use with external nuts (JR-C-EN.5FPKB).

Sold in packages of 5.

	For tubing OD (Package/5)	125 - 175 µm Prod No	175 - 225 µm Prod No	225 - 275 µm Prod No	275 - 325 µm Prod No	325 - 375 µm Prod No
27 mm liners		JR-C-NL.15L-5	JR-C-NL.20L-5	JR-C-NL.25L-5	JR-C-NL.30L-5	JR-C-NL.35L-5
10 mm liners		JR-C-NL.15S-5	JR-C-NL.20S-5	JR-C-NL.25S-5	JR-C-NL.30S-5	JR-C-NL.35S-5

MORE INFO

360 µm Nanovolume® fittings42-45

CONVERSIONS

50 µm	= .002"
100 µm	= .004"
150 µm	= .006"
0.25 mm	= .010"
0.50 mm	= .020"
0.75 mm	= .030"



**For fused silica tubing —
10,000 psi and above**

FOR 360 µm TUBING

SPECIFICATIONS

TUBING OD / THREADS

For FS tubing
360 µm 2-56



MATERIALS

Body HPLC grade SS
Nut HPLC grade SS
Ferrule Gold-plated
nickel

PRESSURE RATING

≥ 689.5 bar (10,000 psi)
(Varies with tubing ID and
material)

These fittings are constructed from HPLC grade stainless steel, with stainless steel nut and a special ferrule which is precision machined from electroformed nickel. For optimal sealing characteristics, the ferrule is gold plated.

		Product No.
Nut/ferrule		JR-C360NFFS
Cap		JR-C360CFS

Bore size:	50 micron Product No.	100 micron Product No.	150 micron Product No.
Union	JR-C360UFS2	JR-C360UFS4	JR-C360UFS6
Reducing union, 1/32" to 360 µm	JR-C360RU.5FS2	JR-C360RU.5FS4	JR-C360RU.5FS6
Reducing union, 1/16" to 360 µm	—	—	JR-C360RU1FS6



**For metal tubing —
up to 20,000 psi**

FOR 360 µm TUBING

SPECIFICATIONS

TUBING OD / THREADS

For metal tubing
360 µm 2-56

MATERIAL

HPLC grade SS

PRESSURE RATING

<1375 bar (20,000 psi)
(Varies with tubing ID and
material)

Our highest pressure Nanovolume® fittings are constructed of HPLC grade stainless steel, including stainless steel nut and ferrule. These fittings are optimized for use with stainless or electroformed nickel tubing.

		Product No.
Nut/ferrule		JR-C360NFS6
Cap		JR-C360C

Bore size:	50 micron Product No.	100 micron Product No.	150 micron Product No.
Union	JR-C360US62	JR-C360US64	JR-C360US66
Reducing union, 1/32" to 360 µm	JR-C360RU.5S62	JR-C360RU.5S64	JR-C360RU.5S66
Reducing union, 1/16" to 360 µm	—	—	JR-C360RU1S66



MORE INFO

- 360 µm OD capillaries
- Fused silica 18
- Stainless 19
- 1/32" Nanovolume® fittings 43

CONVERSIONS

- 50 µm = .002"
- 100 µm = .004"
- 150 µm = .006"
- 0.25 mm = .010"
- 0.50 mm = .020"
- 0.75 mm = .030"

LOW PRESSURE FITTINGS



POLYMERIC

Our low pressure fittings are ideally suited for flow injection analysis, low pressure liquid chromatography, and stream sampling devices. They may be safely used at pressures up to 500 psi and temperatures to 50°C.

LOW PRESSURE POLYMERIC FITTINGS INDEX

NUTS, FERRULES, AND WASHERS

FOR 1/4-28 FLAT-BOTTOM FITTING DETAILS

PPS hex head nuts	
Flangeless	page 47
Flanged	47
Flangeless ferrules	
Collapsible	47
Inverted	47
Flangeless nuts	
PPS hex-head	47
PEEK fingertight nuts	48
Color-coded polyacetal	
fingertight nuts.....	48
Flanged color-coded polypropylene	
fingertight nuts.....	49

UNIONS AND REDUCING UNIONS

Union body, polyamide	49
PEEK unions	50
PEEK bulkhead unions	50
PEEK reducing unions	51
PEEK reducing unions,	
imperial to metric.....	51

TEES, CROSSES, AND MANIFOLDS

Tees	52
Biocompatible mixing tee	53
Crosses	52
Manifolds with 5 and 9 ports	52

PERISTALTIC TUBING ADAPTER SET .. 53

Connect soft tubing to PTFE and PTFE-like tubing with this biocompatible adapter set, which works with peristaltic tubing up to 4.50 mm OD.

ADAPTERS, POLYPROPYLENE

Includes male and female Luer to barbed, 10-32, and 1/4-28 male and female, and other combinations.

PLUGS, POLYPROPYLENE

10-32 and 1/4-28.....	55
-----------------------	----

MICRO VALVES FOR LC AND GC

Simplify your liquid or gas handling application. The unique design of the fitting detail allows a leak-free seal with no potential for rotor damage from overtightening.

i FITTING DESIGNS

VICI Jour offers two types of low pressure fittings for 1/4-28 flat-bottomed fitting details:

- **Flangeless** connections utilize several ferrule designs. The ferrule grips the tubing as the fitting is tightened, without significantly reducing the tubing ID.
- **Flanged** tube end fittings are retained on polymeric tubing by a flange formed around a polypropylene washer. The washer never comes in contact with the mobile phase.

! DISCLAIMER

The maximum holding pressure for any type of connections involving tubing and a ferrule varies considerably with the tubing material the ferrule material, the clearance between tubing OD and ferrule ID, and the shape of the fitting detail.

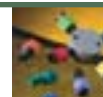

NUTS AND FERRULES

- Economic alternative to PEEK
- Excellent chemical resistance
- For 1/16" or 1/8" OD tubing

Our PPS 1/4-28 fitting series offers excellent chemical and pressure resistance. Three different sealing options are available. PPS nuts are fingertight when used with Color-Sleeve adapters.

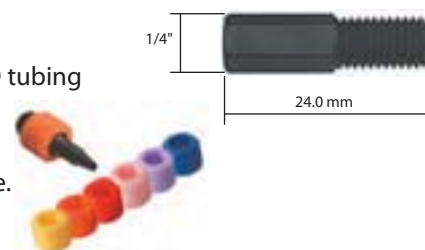

PPS hex-head nuts and collapsible ferrules (flangeless)

1/4-28

Patented* collapsible ferrules are not included. Order separately.

* Patent No. 6,575,501

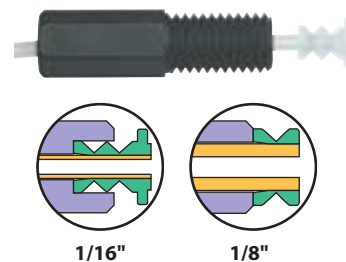

SPECIFICATIONS

TUBING OD / THREADS

1/16" 1/4-28
1/8" 1/4-28

Pressure rating:

OD	Bar	Psi
1/16"	105	1500
1/8"	35	500

(Varies with tubing ID and material)

*Patent No. 6,575,501

(Package/10)		Material	Tubing OD	Product No.
	Nut for use with collapsible ferrule	PPS	1/16"	JR-55050-10
			1/8"	JR-55051-10
	Collapsible ferrules	PCTFE	1/16"	JR-CFL-CB1KF
			1/8"	JR-CFL-CB2KF
		PEEK	1/16"	JR-CFL-CB1PK

PPS hex-head nuts and inverted ferrules (flangeless)

1/4-28

Ferrules are not included. Order separately.

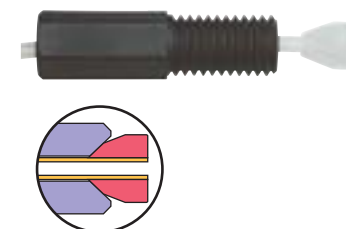

SPECIFICATIONS

TUBING OD / THREADS

1/32" 1/4-28
1/16" 1/4-28
1/8" 1/4-28

PRESSURE RATING

OD	Bar	Psi
1/16"	105	1500
1/8"	35	500

(Varies with tubing ID and material)

(Package/10)		Material	Tubing OD	Product No.
	Nut for use with inverted ferrule	PPS	1/32"	JR-55073-10
			1/16"	JR-55070-10
			1/8"	JR-55071-10
			1.0 mm	JR-55073-10
			2.0 mm	JR-55072-10
	Inverted ferrules	ETFE	1/32"	JR-032-10
			1/16"	JR-041-10
			1/8"	JR-051-10
			1.0 mm	JR-031-10
			2.0 mm	JR-042-10
			3.0 mm	JR-049-10

PPS hex-head nuts and washers (flanged connections)

1/4-28

Washers are not included. Order separately.

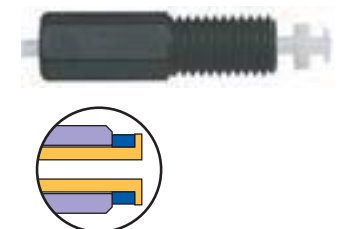

SPECIFICATIONS

TUBING OD / THREADS

1/16" 1/4-28
1/8" 1/4-28

PRESSURE RATING

OD	Bar	Psi
1/16"	105	1500
1/8"	35	500

(Varies with tubing ID and material)

(Package/10)		Material	Tubing OD	Product No.
	Nut for flange/washer connection	PP	1/16"	JR-55060-10
			1/8"	JR-55061-10
	Washer	PP	1/16"	JR-201926-10
			1/8"	JR-201928-10
	Easy-Flange kit (see page 99)			JR-201540

SEE ALSO

High pressure 1/4-28 nuts and ferrules 30
Color-Sleeve adapters 23

MORE INFO

About polymers . 113-114
Chemical resistance of PPS 110-112

CHEMICAL RESISTANCE OF PPS

A = suitable B = marginal
C = not recommended

Chemical class	Resistance	Chemical class	Resistance
Acids, organic	A	Bases	B
Acids, inorganic	B/C*	Esters	A
Aldehydes	A	Halogenated org.	A/B
Alcohols	A	Hydrocarbons	A
* Concentrated halogen acids		Ketones	A

Nuts and ferrules • Flangeless



LOW PRESSURE FITTINGS

PEEK fingertight nuts (flangeless)

1/4-28

- Compatible with all 1/4-28 flat-bottom ports
- Excellent chemical resistance
- For 1/16" or 1/8" OD tubing
- True fingertight – no tools required

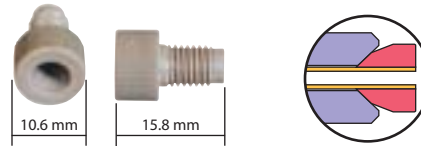

PEEK flangeless nuts in combination with our inverted ferrule do not require a flanging tool. A hand-tightening procedure makes leak-free seals.

With this fitting system, the inert ETFE ferrule is the only part besides the tubing which comes into contact with the fluid stream – the nut is never in contact.

Ferrules are not included. Order separately.

SPECIFICATIONS

TUBING OD / THREADS

1/16"	1/4-28
1/8"	1/4-28

MATERIALS

Nut	PEEK
Ferrules	ETFE

PRESSURE RATING

OD	Bar	Psi
1/16"	105	1500
1/8"	35	500

(Varies with tubing ID and material)

(Package/10)		Material	Tubing OD	Product No.
	Nut for use with inverted ferrule	PEEK	1/16"	JR-20124-10
			1/8"	JR-20116-10
	Inverted ferrules	ETFE	1/16"	JR-041-10
			1/8"	JR-051-10

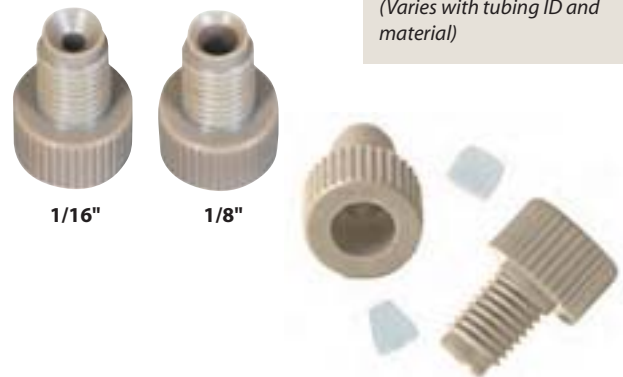

Color-coded fingertight nuts (flangeless)

1/4-28

- Polyacetal – economical alternative to PEEK
- Compatible with all 1/4-28 flat-bottom ports
- For 1/16" or 1/8" OD tubing
- True fingertight – no tools required



Polyacetal flangeless nuts in combination with the inverted ferrule do not require a flanging tool. A hand-tightening procedure makes leak-free seals. With this fitting system, the inert ETFE ferrule is the only part besides the tubing which comes into contact with the fluid stream – the nut is never in contact. Six colors are available.

SPECIFICATIONS

TUBING OD / THREADS

1/16"	1/4-28
1/8"	1/4-28

MATERIAL

Nut	Polyacetal
Ferrules	ETFE

PRESSURE RATING

OD	Bar	Psi
1/16"	70	1000
1/8"	35	500

(Varies with tubing ID and material)

(Package/10)	Nuts	Color	1/16" Product No.	1/8" Product No.
			Green JR-040GR-10	JR-050GR-10
			Blue JR-040BL-10	JR-050BL-10
			Yellow JR-040YL-10	JR-050YL-10
			Red JR-040RE-10	JR-050RE-10
			White JR-040WH-10	JR-050WH-10
			Black JR-040BK-10	JR-050BK-10
	1" long nuts	White	JR-040WL-10	JR-050WL-10
	Inverted ETFE ferrules		JR-041-10	JR-051-10



TECH TIP

The inert ETFE ferrule used with these nuts is the only part besides the tubing which is in contact with the fluid stream.

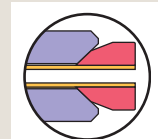



Color-coded fingertight nuts (flanged connections)

1/4-28

SPECIFICATIONS

TUBING OD / THREADS

1/16" 1/4-28
1/8" 1/4-28

MATERIAL

Fiberglass-reinforced polypropylene

PRESSURE RATING

<30 bar (435 psi)
(Varies with tubing ID and material)

- For flanged connections
- Compatible with all 1/4-28 flat-bottom ports
- For 1/16" or 1/8" OD tubing
- Fiberglass-reinforced PP with PP washers

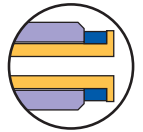
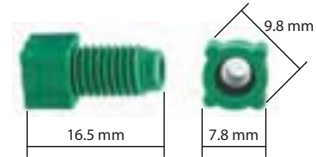

For those systems requiring or preferring flanged connections, use these fiberglass-reinforced fittings with our Easy-Flange flanging tool and polypropylene washers to make a clean connection. The flange on the tubing ensures that the washer never comes in contact with the mobile phase.

Six colors are available.

(Package/10)	Nuts	Color	1/16"	1/8"
			Product No.	Product No.
		Green	JR-202123-10	JR-202143-10
		Blue	JR-202122-10	JR-202142-10
		Yellow	JR-202124-10	JR-202144-10
		Red	JR-202125-10	JR-202145-10
		White	JR-201094WH-10	JR-201580WH-10
		Black	JR-201094BK-10	JR-201580BK-10
	1" long nuts	White	JR-202120-10	JR-202119-10
		Black	JR-202118-10	JR-202121-10
	Polypropylene washer	10	JR-201926-10	JR-201928-10

Union body for flanged connections

1/4-28

SPECIFICATIONS

TUBING OD / THREADS

1/16" 1/4-28
1/8" 1/4-28

MATERIAL

Polyamide

- For flanged 1/4-28 flat-bottom connections
- Through bore low pressure union
- For 1/16" or 1/8" OD tubing
- Completely inert and biocompatible

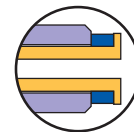

Flanged fittings are not included.

Order PPS hex-head flanged nuts or color-coded fingertight flanged nuts separately.

(Package/5)	Union body, polyamide	Product No.
		JR-060-5

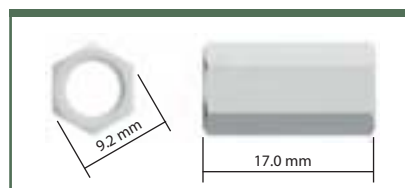

TECH TIP

Use our Easy-Flange kit for forming flanges on tubing 99

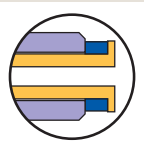

Unions and bulkhead unions • Flangeless



LOW PRESSURE FITTINGS

PEEK unions

1/4-28

- For easy connection of low pressure solvent lines
- Low dead volume
- For 1/16" or 1/8" OD tubing
- Flat-bottomed 1/4-28 fitting details
- Completely inert and biocompatible

These unions facilitate the quick and reliable connection of two pieces of 1/16" or 1/8" OD tubing. Use with color-coded adapters for easy solvent line identification.

These are available either as the body only, or complete with fittings.

A union with fittings includes:

- PEEK low pressure union
- 2 PPS flangeless hex-head nuts
- ETFE inverted ferrules
- Color-Sleeve adapters

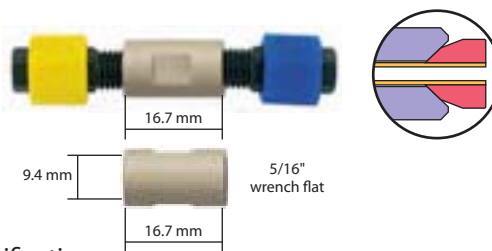

SPECIFICATIONS

TUBING OD / THREADS

1/16"	1/4-28
1/8"	1/4-28

MATERIALS

Body	PEEK
Nut	PPS
Ferrules	ETFE

PRESSURE RATING

OD	Bar	Psi
1/16"	105	1500
1/8"	35	500

(Varies with tubing ID and material)

		Tubing OD	Bore (mm)	Product No.
(Sold individually)	Union, with fittings	1/16"	0.50	JR-1064
			0.75	JR-1068
		1/8"	1.30	JR-1065
	Body only	1/16"	0.50	JR-064
			0.75	JR-068
		1/8"	1.30	JR-065

		Tubing OD	Product No.
(Package/10)	PPS flangeless nuts	1/16"	JR-55070-10
		1/8"	JR-55071-10
	Inverted ETFE ferrules	1/16"	JR-041-10
		1/8"	JR-051-10

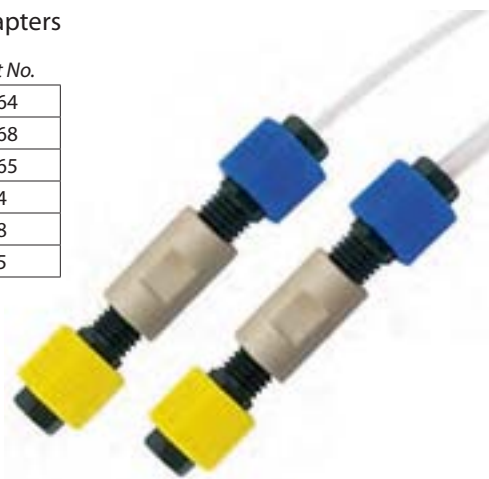

PEEK bulkhead unions

1/4-28

- Panel mounting (10 mm hole required, max 9 mm thick)
- Low dead volume
- For 1/16" or 1/8" OD tubing
- Completely inert and biocompatible
- For easy connection of low pressure solvent lines

Bulkhead unions are designed to be mounted through an instrument panel or on a bracket.

They are sold complete with fittings, and include:

- 2 PPS flangeless hex-head nuts
- 2 ETFE inverted ferrules
- 2 Color-Sleeve adapters



SPECIFICATIONS

TUBING OD / THREADS

1/32"	1/4-28
1/16"	1/4-28
1/8"	1/4-28

MATERIALS

Body	PEEK
Nut	PPS
Ferrules	ETFE

PRESSURE RATING

OD	Bar	Psi
1/16"	105	1500
1/8"	35	500

(Varies with tubing ID and material)

		Bore (mm)	Tubing OD	Product No.
(Sold individually)	Bulkhead union, with fittings	0.75	1/16"	JR-CBUMPK
		1.50	1/8"	JR-CBULPK

		Tubing OD	Product No.
(Package/10)	PPS flangeless nuts	1/16"	JR-55070-10
		1/8"	JR-55071-10
	Inverted ETFE ferrules	1/16"	JR-041-10
		1/8"	JR-051-10

SEE ALSO

Color-coded fingertight flanged nuts49
 Color-Sleeve adapters, in 12 colors23
 High pressure PEEK unions22
 PPS hex-head flanged nuts47

TECH TIP

Use our impermeable tubing to avoid gas diffusion in the solvent lines 17



PEEK reducing unions

IMPERIAL TO METRIC 1/4-28

SPECIFICATIONS

TUBING OD / THREADS

1/32"	1/4-28
1/16"	1/4-28
1/8"	1/4-28

MATERIALS

Body	PEEK
Nuts	PPS
Ferrules	ETFE

PRESSURE RATING

≤48 bar (700 psi)
(Varies with tubing ID and material)

- Connects 1/16", 1/8", 1 mm, 2 mm, and 3 mm OD polymeric tubing
- Completely inert and biocompatible

With these reducing unions, metric tubing can be connected to imperial fittings on valves and LC systems.

A reducing union with fittings includes:

- PEEK low pressure reducing union
- 1 PPS flangeless hex-head nut, imperial size noted
- 1 PPS flangeless hex-head nut, metric size noted
- ETFE inverted ferrules
- Color-Sleeve adapters



		Tubing OD	Bore (mm)	Product No.
(Sold individually)	Reducing union, with fittings	1/32" to 1 mm	0.50	JR-0640
		1/16" to 2 mm	0.75	JR-0680
		1/8" to 3 mm	1.30	JR-0650

		Material	Tubing OD	Product No.
Replacement fittings				
(Package/10)	Nut for use with inverted ferrule	PPS	1/32"	JR-55073-10
			1/16"	JR-55070-10
			1/8"	JR-55071-10
			1.0 mm / 1/32"	JR-55073-10
			2.0 mm	JR-55072-10
	Inverted ferrules	ETFE	1/32"	JR-032-10
			1/16"	JR-041-10
			1/8"	JR-051-10
			1.0 mm	JR-031-10
			2.0 mm	JR-042-10
			3.0 mm	JR-049-10



PEEK reducing unions

IMPERIAL 1/2-20 to 1/4-28

- Connects 1/4" and 1/8" OD tubing
- Completely inert and biocompatible
- Low dead volume

PEEK reducing unions are sold complete with fittings, and include:

- One 1/8" flangeless nut, white polypropylene
- One 1/8" ferrule, PEEK
- One 1/4" flangeless nut, PPS
- One 1/4" ferrule, CTFE

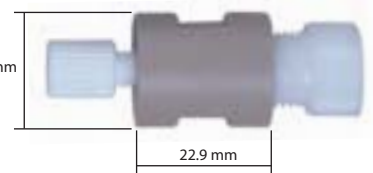

		Bore (mm)	Tubing OD	Product No.
(Sold individually)	Reducing union with fittings	1.5	1/4" to 1/8"	JR-CU4LPK

		Material	Tubing OD	Product No.
Replacement fittings				
(Sold individually)	Flangeless nut, white propylene	White propylene	1/8"	JR-CFL-2W-S
		PPS	1/4"	JR-CFL-4PPS
	Ferrule	PEEK	1/8"	JR-CFL-CB2PK-S
		PCTFE	1/4"	JR-CFL-CB4KF-S

TECH TIP

While our PEEK unions are typically used with inverted ferrules, collapsible ferrules or flanged connections can also be used.



Standard: Inverted ferrule

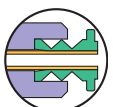

Collapsible ferrule

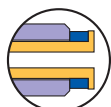

Flanged

SPECIFICATIONS

TUBING OD / THREADS

1/8"	1/4-28
1/4"	1/2-20

MATERIALS

Body	PEEK
Nuts	1/8" PP
	1/4" PPS
Ferrules	1/8" PEEK
	1/4" PCTFE

PRESSURE RATING

<35 bar (500 psi)
(Varies with tubing ID and material)

Tees, crosses, and manifolds

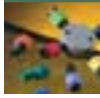

LOW PRESSURE FITTINGS

PEEK tees, crosses, and manifolds

1/4-28

- For 1/16" or 1/8" OD tubing
- Flat-bottomed 1/4-28 fitting details
- Completely inert and biocompatible

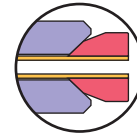

These VICI Jour connectors for low pressure applications are machined from PEEK. The bodies have 1/4-28 female ports which accept any flanged or flangeless fittings for 1/8" or 1/16" OD tubing.

Choose smaller through-holes for applications where low flowrate or low dead volume is required. Fittings with 1.50 mm through-holes are preferred for high flowrate applications.

These are available as the body only, or complete with fittings.

The appropriate number of the following are included when fittings are ordered:

- PPS flangeless hex-head nuts
- ETFE inverted ferrules
- Color-Sleeve adapters

Sold individually.

		Tubing OD	Bore (mm)	With fittings	Body only
				Product No.	Product No.
<i>(Sold individually)</i>	Tees	1/16"	0.50	JR-6029	JR-6034
			0.80	JR-6030	JR-6032
		1/8"	1.50	JR-6031	JR-6033
	Crosses	1/16"	0.50	JR-6039	JR-6044
			0.80	JR-6040	JR-6042
		1/8"	1.50	JR-6041	JR-6043
Manifolds	5 ports	1/16"	0.75	JR-C5M1PK	—
		1/8"	1.50	JR-C5M2PK	—
	9 ports	1/16"	0.75	JR-C9M1PK	—
		1/8"	1.50	JR-C9M2PK	—

		Tubing OD	Product No.
Replacement fittings			
<i>(Package/10)</i>	PPS flangeless nuts	1/16"	JR-55070-10
		1/8"	JR-55071-10
	Inverted ETFE ferrules	1/16"	JR-041-10
		1/8"	JR-051-10



SPECIFICATIONS

TUBING OD / THREADS

1/16"	1/4-28
1/8"	1/4-28

MATERIALS

Body	PEEK
Nut	PPS
Ferrules	ETFE

BODY SIZES

See chart below

PRESSURE RATING

OD	Bar	Psi
1/16"	105	1500
1/8"	35	500

(Varies with tubing ID and material)

TECH TIP

While our PEEK tees and crosses are typically used with inverted ferrules, collapsible ferrules or flanged connections can also be used.



Standard:
Inverted ferrule

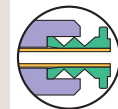

Collapsible
ferrule



Flanged
ferrule

TECH TIP

Use our impermeable tubing to avoid gas diffusion in the solvent lines 17

SEE ALSO

Color-Sleeve adapters, in 12 colors 23
High pressure PEEK tees 34
PPS hex-head flanged nuts 47

BODY SIZES

	Diameter	Thickness
Tees	25.0 mm	12.0 mm
Crosses	25.0 mm	12.0 mm
Manifolds	5 ports	22.2 mm
	9 ports	22.2 mm
		17.1 mm
		28.6 mm

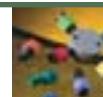

PEEK mixing tees

1/4-28

SPECIFICATIONS

TUBING OD / THREADS

1/16" 1/4-28
1/8" 1/4-28

MATERIALS

Body PEEK
Nut PPS
Ferrules ETFE

PRESSURE RATING

OD	Bar	Psi
1/16"	105	1500
1/8"	35	500

(Varies with tubing ID and material)

MIXING VOLUME

Bore	Volume
0.75 mm	25 µl
1.50 mm	100 µl

- For 1/16" or 1/8" OD tubing
- Mountable
- Completely inert and biocompatible

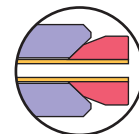

A unique mixing results from the turbulence created by the introduction angle of the solvents. The mixing is much more thorough than with a conventional tee.

Typically our inverted ferrules are used in these fittings, but the 1/4-28 flat-bottomed details will also accept collapsible ferrule or flanged fittings.

These are available as the body only, or complete with fittings. A mixing tee with fittings includes:

- 3 PPS flangeless hex-head nuts
- 3 ETFE inverted ferrules
- 3 Color-Sleeve adapters

Sold individually.

		Tubing OD	Bore (mm)	Product No.
(Sold individually)	Mixing tee, with fittings	1/16"	0.75	JR-CM1XPK
		1/8"	1.50	JR-CM2XPK
	Body only	1/16"	0.75	JR-B-CM1XPK
		1/8"	1.50	JR-B-CM2XPK



		Tubing OD	Product No.
Replacement fittings			
(Package/10)	PPS flangeless nuts	1/16"	JR-55070-10
		1/8"	JR-55071-10
	Inverted ETFE ferrules	1/16"	JR-041-10
		1/8"	JR-051-10

Peristaltic tubing adapter set

1/4-28

SPECIFICATIONS

TUBING OD / THREADS

1/16" 1/4-28
1/8" 1/4-28

MATERIALS

Body PEEK
Bushings PPS
Nut PPS
Ferrules ETFE

BORE

1.50 mm

BODY SIZE

28 mm long,
12 mm diameter.

- For connecting soft tubing to PTFE and PTFE-like tubing
- Works with peristaltic tubing up to 4.50 mm OD
- For 1/16" and 1/8" PTFE and PTFE-like tubing
- Biocompatible
- Low dead volume

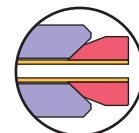

This "one-fits-all" set consists of everything needed to connect 1/16" or 1/8" OD PTFE and PTFE-like tubing to soft tubing (such as silicone), up to 4.5 mm in OD, minimum 0.5 mm ID.

The adapter includes:

- 3 different bushings (for the different soft tubing ODs)
- 2 PPS nuts (one each for 1/16" and 1/8" OD tubing)
- 2 ETFE inverted ferrules (one each for 1/16" and 1/8" OD)
- 2 Color-Sleeve adapters

Sold individually.

	Product No.
PEEK adapter for peristaltic to PTFE tubing connection	JR-PTAS













SEE ALSO

Color-Sleeve adapters, in 12 colors..... 23





Polypropylene adapters

	Inlet		Outlet		Product No.		
<i>(Package/10)</i>	Male	Luer	Barbed	1/16"	 JR-070211-10		
				3/32"	 JR-070212-10		
				1/8"	 JR-070213-10		
		Male	10-32	Barbed	10-32	 JR-070224-10	
					1/4-28	 JR-070225-10	
					1/4-28 UNF BST	 JR-070226-10	
		1/4-28	Barbed	1/16"	1/16"	 JR-071123-10	
					1/8"	 JR-071323-10	
			10-32	Barbed	1/16"	1/16"	 JR-071124-10
						1/8"	 JR-071324-10
	Female	Luer	Barbed	1/16"	 JR-070111-10		
				3/32"	 JR-070112-10		
				1/8"	 JR-070113-10		
			Female	Luer	Female	 JR-070101-10	
					Male	10-32	 JR-070124-10
						1/4-28	 JR-070123-10
		Straight through tube fitting	Barbed to barbed	1/16"	 JR-073210-10		
				3/32"	 JR-073220-10		
				1/8"	 JR-073230-10		
		<i>(Sold individually)</i>	Male	1/4-28 UNF BST	Barbed	1/16"	 JR-075012
Flat bottom	1/4-28 UNF BST		Barbed	1/8" ID	 JR-075013		

SPECIFICATIONS

MATERIAL
Polypropylene

 **SEE ALSO**

High pressure PEEK adapters 35
High pressure plugs . . . 31



Polypropylene plugs

1/4-28 OR 10-32

SPECIFICATIONS

THREADS

10-32 or 1/4-28

MATERIAL

Polypropylene

(Package/10)			Product No.
	10-32 male		JR-072450-10
	1/4-28 male		JR-072350-10
	1/4-28 male, flat bottom		JR-201999-10

Micro valves for GC and LC

1/4-28

SPECIFICATIONS

TUBING OD / THREADS

1/16" 1/4-28

1/8" 1/4-28

DIMENSIONS

Bore 1.50 mm

Height 44.70 mm

Diameter 27.94 (without fittings)

MATERIALS

Wetted parts

PEEK, PTFE

Body POM

Nuts PPS

Ferrules PCTFE

PRESSURE RATING

200 psi gas

Tested with helium using

1/16" OD x 0.84 mm ID

PTFE tubing with PEEK

collapsible ferrules

200 psi liquid

Tested with isopropanol

using 1/8" OD x 0.75 mm

ID PTFE tubing with CTFE

collapsible ferrules

- Compact 1" design
- Convenient panel mount, hole diameter 8 mm (0.3125"), 6 mm maximum thickness
- Biocompatible and inert
- Variety of configurations

Simplify your liquid or gas handling application with a VICI Jour sampling micro valve. The unique design of the fitting detail allows a leak-free seal with no potential for rotor damage from overtightening. Internal parts are PEEK and PTFE.

Includes flangeless PPS fittings and CTFE collapsible ferrules for 1/8" OD tubing.

Sold individually.



		Product No.
"T" flow path	3 ports	JR-660100
	4 ports	JR-660110
180° flow path	2 ports	JR-660200
	4 ports	JR-660210
90° flow path	2 ports	JR-660300
	3 ports	JR-660310
	4 ports	JR-660320

		Material	Tubing OD	Product No.	
Replacement fittings	(Package/10)	Nut for use with collapsible ferrule	PPS	1/16"	JR-55050-10
				1/8"	JR-55051-10
	Collapsible ferrules	PEEK	1/16"		JR-CFL-CB1PK
		CTFE	1/8"		JR-CFL-CB2KF

FLOW PATH CONFIGURATIONS

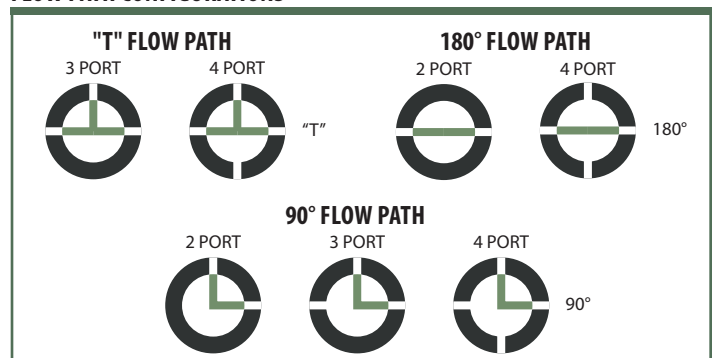

SEE ALSO

- High pressure PEEK tees..... 34
- PPS hex-head flanged nuts..... 47
- Color-Sleeve adapters, in 12 colors..... 23



TECH TIP

Use our impermeable tubing to avoid gas diffusion in the solvent lines 17

TECH TIP

While micro valves are typically used with collapsible ferrules, inverted ferrules or flanged connections can also be used. See page 47.

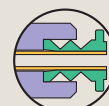

STANDARD:
Collapsible ferrule



INVERTED FERRULE



FLANGED

FILTERS

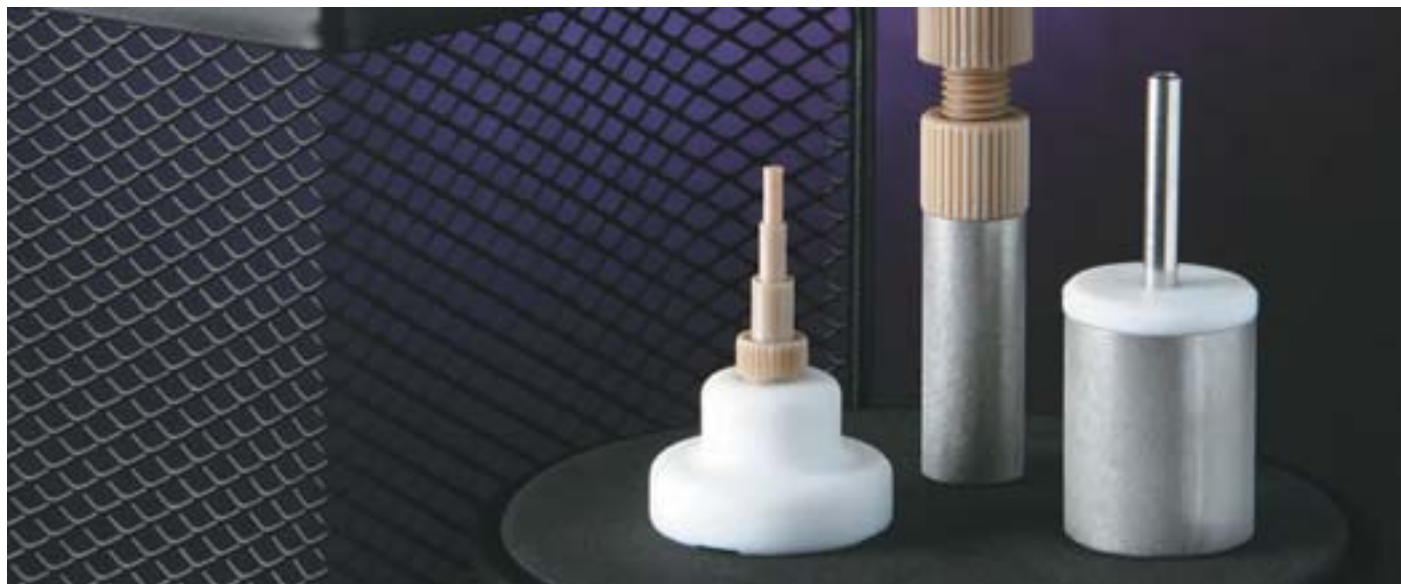

METAL AND POLYMERIC

Filters trap foreign particulates from sample and mobile phase streams before they can damage valuable columns and instruments.

FILTERS INDEX

LOW PRESSURE FILTERS

In-line filter cartridges.....	page 56
Mobile phase filters	
Last Drop	57
Economy Last Drop	57
Last Drop biocompatible	
glass filter	58
No-Met biocompatible.....	59
Filter/spargers	
Last Drop	60
Stainless steel.....	61

HIGH PRESSURE FILTERS

PEEK	
In-line filter kit.....	62
Sure-Guard.....	62
Precolumn filter kit	63
Replacement frits	63
Stainless	
UHPLC precolumn filter	64
Inline filter.....	65
Replacement frits	64-65

In-line filter cartridges

LOW PRESSURE

- Easy to replace
- Compact design
- Fit all 1/4-28 fitting details
- Three porosity options

These convenient-to-use filters can be simply dropped into any 1/4-28 fitting detail, such as in a union. The filters are constructed of PTFE and PCTFE, with a Type 316 stainless low-pressure-drop screen. The inner design of the cartridge ensures the equal distribution of the solvent to the screen.

	Pore size	Maximum flow rate *	Product No.
(Package/5)	2 µm	30 ml/min	JR-CFE-S2-5
	10 µm	30 ml/min	JR-CFE-S10-5
	75 µm	30 ml/min	JR-CFE-S75-5



SPECIFICATIONS

MATERIALS

Cartridge PTFE/
PCTFE

Filter screen: 316 SS

DIMENSIONS

1/4-28 detail

OD 5.20 mm

Thickness 2.03 mm

Bore 0.8 mm

Filter surface diameter 2 mm

TOLERANCES

±0.05 mm (.002")

i NOTES

* Flowrate measured with methanol/water (1:1), ultrasonic degassed, helium sparging to prevent regassing.

t TECH TIP

We recommend using these in-line filter cartridges in combination with our low pressure fittings:

PEEK unions..... 50

Tees and crosses..... 52

Manifolds..... 52

Micro valves..... 55

→ DISCLAIMER

The maximum holding pressure for any type of connections involving tubing and a ferrule varies considerably with the tubing material, the ferrule material, the clearance between tubing OD and ferrule ID, and the shape of the fitting detail.



Last Drop mobile phase filters

LOW PRESSURE

SPECIFICATIONS

MATERIALS

Body PTFE
Frits PTFE/
316 SS/PE

CONNECTIONS

Stepped tubing version is for 1.5, 2.2, and 3.5 mm ID tubing

Fitting version (for 1/8" OD tubing) includes PEEK 1/4-28 nut with ETFE ferrule

- No loss of mobile phase
- Biocompatible PTFE frits or stainless steel frits
- Three porosity options
- Two connector types: stepped tubing and 1/4-28 fitting



The Last Drop mobile phase filter allows more analyses per batch of mobile phase and helps reduce hazardous waste. The flat filter element sits parallel to the bottom of the reservoir, allowing the Last Drop to filter all but the last 2% of the mobile phase from the reservoir without drawing air into the system. Compare this with conventional cylindrical filters that can begin to draw air into the system when nearly 10% of the solvent remains in the reservoir.

The Last Drop mobile phase filter consists of a 316 stainless steel, PTFE 2.5 µm, or a hydrophobic PE filter element pressed into an inert PTFE housing. The top of the housing has a 1/4-28 nut and ferrule or a stepped PEEK fitting connector which slips into 1.5, 2.2, or 3.5 mm ID pump inlet lines.

Filter material	Pore size	Maximum flow rate *	Stepped tubing connector	Fitting connector
			Product No.	Product No.
PTFE	2.5 µm	1.2 ml/min	JR-9000-0520	JR-9000-0520F
	5 µm	2.6 ml/min	JR-9000-0521	JR-9000-0521F
	10 µm	3.5 ml/min	JR-9000-0522	JR-9000-0522F
Polyethylene	10 µm	11 ml/min	JR-9000-0522H	JR-9000-0522HF
Stainless	2 µm	28 ml/min	JR-9000-0530	JR-9000-0530F
	5 µm	30 ml/min	JR-9000-0531	JR-9000-0531F
	10 µm	30 ml/min	JR-9000-0532	JR-9000-0532F



NOTES

* Flowrate measured with methanol/water (1:1), ultrasonic degassed, helium sparging to prevent regassing.

TECH TIPS

- Economy Last Drop mobile phase filters are easy to replace - easy to clean. Use ultrasound or replace with a new filter.
- Connect the Economy Last Drop filter with 1/8" OD tubing:
 - ETFE tubing.....13
 - FEP tubing... ..16
 - PFA tubing..... 13
 - PTFE tubing 14-15
- We recommend metal-free PTFE or glass filters for sensitive biochromatography applications where metal surfaces may corrode or interact with samples.

SEE ALSO

Last Drop mobile phase filter/spargers..... 60

SPECIFICATIONS

MATERIALS

Body PTFE
Frits PTFE/316 SS

TUBING OD

For 1/8" OD tubing

Economy Last Drop mobile phase filters

LOW PRESSURE

- Very competitively priced
- Biocompatible PTFE frits or stainless steel frits
- Three porosity options
- Two diameters

Economy mobile phase filters come in two body diameters, for various dimensions of bottle necks.

The filter body is made of PTFE, which is resistant to virtually all common mobile phases.

Frit material	Body OD	Pore size	Maximum flow rate *	Product No.
PTFE	19 mm	2.5 µm	1.2 ml/min	JR-4676-2.5TF
		5 µm	2.6 ml/min	JR-4676-5TF
		10 µm	3.5 ml/min	JR-4676-10TF
	22 mm	2.5 µm	1.2 ml/min	JR-4677-2.5TF
		5 µm	2.6 ml/min	JR-4677-5TF
		10 µm	3.5 ml/min	JR-4677-10TF
Stainless steel	19 mm	2 µm	30 ml/min	JR-4676-2
		10 µm	30 ml/min	JR-4676-10
		10 µm	30 ml/min	JR-4676-10
	22 mm	2 µm	30 ml/min	JR-4677-2
		10 µm	30 ml/min	JR-4677-10
		10 µm	30 ml/min	JR-4677-10

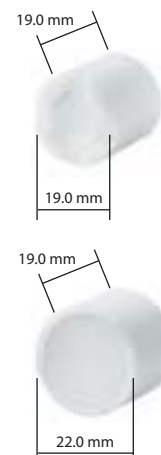



FILTERS

Last Drop biocompatible glass mobile phase filters LOW PRESSURE

- The solution for biocompatibility and high flowrates
- Easy-push tubing connection

Because it has a glass frit, the flowrate can be much higher with this filter than with PTFE mobile phase filters. The glass foot allows withdrawal of nearly all of the mobile phase – less than 2% is left in the bottle.

Includes 1/8" tubing connector.



SPECIFICATIONS

MATERIALS

Body Glass
Frit Glass

TUBING OD

For use with 1/8" tubing

<i>Frit material</i>	<i>Pore size</i>	<i>Maximum flow rate *</i>	<i>Product No.</i>
Glass	1.0 - 1.6 µm	30 ml/min	JR-9000-0520B
	10-16 µm	50 ml/min	JR-9000-0526G
	40-100 µm	200 ml/min	JR-9000-0528G

<i>For tubing</i>	<i>Size</i>	<i>Qty/pkg</i>	<i>Product No.</i>
Replacement connectors			
1/8" OD	6.8 mm	1	JR-9000-0525GC



i NOTES

- * Flowrate measured with methanol/ water (1:1), ultrasonic degassed, helium sparging to prevent regassing.

t TECH TIPS

- Because they are hydrophobic, No-Met filters may initially require some priming with methanol or acetonitrile.
- Connect the No-Met filter with 1/8" OD tubing:

ETFE tubing.....13
FEP tubing... ..16
PFA tubing. 13
PTFE tubing14-15



No-Met biocompatible mobile phase filters

LOW PRESSURE

SPECIFICATIONS

MATERIALS

Body PTFE/
Polyethylene
Adapter PEEK
Fitting PEEK
Ferrule ETFE

TUBING OD

For 1/8" OD tubing

- Very competitively priced
- Inert and biocompatible
- Replacement filters
- Also recommended for IC

Stainless steel in the flowpath is not acceptable in a growing number of applications involving the separation of biomolecules. High salt buffers can corrode stainless steel, and the metal ions released from metallic filters may contaminate or otherwise react with the biomolecules of interest.



The No-Met polyethylene filter is designed for these applications, with inert polymeric fittings for 1/8" tubing and a 20 µm filter effectively eliminating metal contamination from the fluid path. Use them for IC and biochromatography applications.

No-Met filters can be used at flow rates up to 500 ml/min, measured with methanol/water (1:1), ultrasonically degassed. Flow rates can vary with solvent and tubing ID.

The economy version can easily be slipped over 1/8" OD tubing, with no fitting required.



Connection	Filter material	Pore size	Maximum flow rate *	Product No.
1/4-28 nut and ferrule	PTFE	5 µm	2.2 ml/min	JR-32171
	Polyethylene	<20 µm	500 ml/min	JR-32178
Economy slip-on connection	Polyethylene	20 µm	300 ml/min	JR-32174

Filter material	Pore size	Maximum flow rate *	Product No.
Replacement element			
PTFE	20 µm	2.2 ml/min	JR-32172
Polyethylene	<20 µm	500 ml/min	JR-32179



FILTERS

Last Drop filter/sparger

LOW PRESSURE

The Last Drop filter/sparger combines filtration and sparging in a single unit. The PTFE housing contains a mobile phase filter with a stainless steel, PTFE, or hydrophobic PE filter element.

Spargers have a porosity of 10 microns.

The filter/sparger includes:

- PEEK stepped connector which slips into 1.5, 2.2, or 3.5 mm ID solvent lines
- 1/4-28 nut and ferrule for the sparging line



SPECIFICATIONS

MATERIALS

Body PTFE
 Frits PTFE/
 316 SS/PE
 Stepped tubing connector PEEK
 Nut PEEK
 Ferrule ETFE

CONNECTIONS

Stepped tubing connector for 1.5, 2.2, and 3.5 mm ID tubing
 PEEK 1/4-28 nut with ETFE ferrule for 1/8" OD tubing

Filter material	Pore size	Maximum flow rate *	Product No.
PTFE	2.5 µm	1.2 ml/min	JR-9000-0602
	5 µm	2.6 ml/min	JR-9000-0603
	10 µm	3.5 ml/min	JR-9000-0604
Polyethylene	10 µm	11 ml/min	JR-9000-0604H
Stainless	2 µm	28 ml/min	JR-9000-0640
	5 µm	30 ml/min	JR-9000-0641
	10 µm	30 ml/min	JR-9000-0642





Stainless steel mobile phase filter/helium sparger

LOW PRESSURE

SPECIFICATIONS

MATERIALS

Body	SS316
Pipe	SS316
Pipe adapter	PTFE
Fitting adapter	PEEK
Fittings	PEEK
Ferrules	ETFE

- Ideal for helium sparging
- Different porosity options
- Fitting and pipe connectors



VICI Jour mobile phase filters protect HPLC systems from small particles in the mobile phase. These filters are made from SS316 with PEEK or PTFE connectors and are suitable for most solvents. The complete line has versions for both analytical and preparative applications.

VICI Jour helium spargers (2 µm versions) offer an inexpensive way to prepare and maintain mobile phases free of dissolved gases. Connected to a regulated supply of helium gas (0-400 mL/min.) they effectively remove dissolved oxygen, nitrogen, and other atmospheric gases from the mobile phase.

Fitting type	Tubing/ pipe size	Pore size	Maximum flow rate *	Product No.	
1/4-28	1/16"	2 µm	35 ml/min	JR-367016-2	
		10 µm	35 ml/min	JR-367016-10	
		20 µm	35 ml/min	JR-367016-20	
	1/8"	2 µm	35 ml/min	JR-367008-2	
		10 µm	100 ml/min	JR-367008-10	
		20 µm	120 ml/min	JR-367008-20	
Stepped	1/16", 3/32", and 3.76 mm tubing ID	2 µm		JR-8000-0495-2	
		10 µm		JR-8000-0495-10	
		20 µm		JR-8000-0495-20	
Pipe	1/8"	2 µm	95 ml/min	JR-3675-2	
		2 µm	50 ml/min	JR-3678-2	
	1/8"	25 µm	100 ml/min	JR-3678-25	
		2 µm	100 ml/min	JR-3678-25	

t TECH TIPS

- We recommend metal free PTFE filters for sensitive biochromatography applications where metal surfaces may corrode or interact with samples.
- We recommend our impermeable tubing to prevent "regassing" of helium-degassed solvents.

➔ SEE ALSO

Last Drop mobile phase filters 57



FILTERS

PEEK in-line filter kit

HPLC

- Replaceable metal-free polyethylene frits and biocompatible titanium frits
- 100% biocompatible
- Minimal hold-up volume
- Different porosity options

The PEEK in-line filter traps fines and other particles from samples and mobile phases before they damage valuable instruments and columns.

This female-to-female design is made entirely of PEEK, with PEEK-encased titanium or polyethylene filter elements, for biocompatibility and chemical resistance. The design has virtually no hold-up volume and can be used in analytical applications with virtually no band broadening or loss of efficiency.

Sold individually.



SPECIFICATIONS

MATERIALS

Body PEEK
Frit Titanium, Polyethylene

BORE

0.25/0.4 mm

TUBING OD / THREADS

1/16" 10-32

PRESSURE RATING

<350 bar (< 5000 psi)

Frit material	Pore size	Internal volume (µL) *	Maximum flow rate **	Product No.
Titanium	0.5 µm	9.50	25 ml/min	JR-68247
	2 µm	11.85	30 ml/min	JR-68253
	5 µm	12.7	30 ml/min	JR-68256
	10 µm	13.2	30 ml/min	JR-68257
Polyethylene	10 µm	13.9	30 ml/min	JR-68257PE

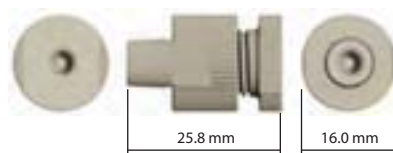

Sure-Guard in-line filter kit

HPLC

- Disposable filter guard
- Minimal hold-up volume
- Titanium (biocompatible) and stainless steel frits, permanently pressed in place
- Two porosity options

The VICI Jour Sure-Guard disposable in-line filter offers an easy and inexpensive way to protect valuable columns against fines and particles. It is easily connected directly to any column, with an inlet for 1/16" OD tubes and 10-32 threads. The VICI Jour Sure-Guard can be changed in seconds without tools.

Sold in packages of three. Waters type filter kits are sold individually.

SPECIFICATIONS

MATERIALS

Body: PEEK
Frit: Stainless, Titanium

BORE

0.4 mm

THREADS

10-32 female to 10-32 male

PRESSURE RATING

<350 bar (< 5000 psi)

Frit material	Pore size	Internal volume (µL) *	Maximum flow rate **	Product No.	Waters type Product No.
Stainless steel	0.5 µm	0.45 µL	30 ml/min	JR-0611-SS05-3	JR-0641-SS05
	2 µm	0.61 µL	30 ml/min	JR-0611-SS2-3	JR-0641-SS2
Titanium	0.5 µm	0.45 µL	30 ml/min	JR-0611-TI05-3	JR-0641-TI05
	2 µm	0.61 µL	30 ml/min	JR-0611-TI2-3	JR-0641-TI2



NOTES / TECH TIPS

See facing page.



PEEK precolumn filter kit

HPLC

SPECIFICATIONS

MATERIALS

Body PEEK
Frit Titanium,
Polyethylene

BORE

0.25/0.4 mm

TUBING OD / THREADS

1/16" 10-32

PRESSURE RATING

<350 bar (< 5000 psi)

- 100% biocompatible
- Minimal hold-up volume
- Replaceable metal-free polyethylene frits and biocompatible titanium frits encased in PEEK
- Different porosity options

The VICI Jour precolumn filter kit has a standard 10-32 fitting and fits direct to most column types without introducing additional dead volume.

The filter kit protects expensive columns against fine particles, which may otherwise accumulate on the column frit and lead to split peaks and high backpressure.

Sold individually.

Frit material	Pore size	Internal volume (µL) *	Maximum flow rate **	Product No.
Titanium	0.5 µm	11.5	30 ml/min	JR-68258
	2 µm	13.85	30 ml/min	JR-68262
	5 µm	14.7	30 ml/min	JR-68263
	10 µm	15.2	30 ml/min	JR-68264
Polyethylene	10 µm	15.9	30 ml/min	JR-68264PE

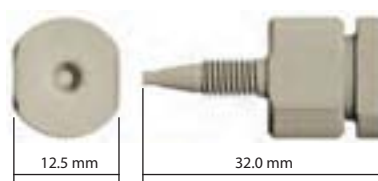

NOTES

* The internal volume is the hold-up volume between the end of the connecting tube and the filter 10-32 connector outlet, including the frit volume.

** Flowrate measured with methanol/water (1:1), ultrasonic degassed, helium sparging to prevent regassing.

TECH TIP

We recommend 2 µm frits for columns with 5 µm or larger particles, and 0.5 µm frits for smaller particles.

NOTE

Polyethylene frits are for single use only.

SEE ALSO

Calculation of frit volume 109
PEEK-encased stainless frits 88

Replacement frits

FOR PEEK IN-LINE AND PRECOLUMN FILTER KITS

Replacement frits for PEEK precolumn filter kit and PEEK in-line filter kit (see facing page).

Frit material	Pore size	Internal volume (µL) *	Qty/pkg	Product No.
Titanium	0.5 µm	6.87	5	JR-1125-05P-5
	2 µm	9.24	5	JR-1125-2P-5
	5 µm	10.04	5	JR-1125-5P-5
	10 µm	10.56	5	JR-1125-10P-5
Polyethylene	10 µm	11.31	5	JR-1151-10P-5



FILTERS

Stainless steel precolumn filter

UHPLC

- (U)HPLC
- Mimimized hold-up volume
- Four porosity options
- Fewer connections compared to in-line filters
- Works with 1/16" column connections from all manufacturers



VICI Jour's new stainless steel precolumn filter is based on our well-known in-line filter. The design of this precolumn filter reduces the number of connections compared to a standard in-line filter, increasing the stability and reducing the potential of leakage.

The small bore sizes (0.15 mm in the nut/body and 0.13 mm in the tubing) guarantee a very small (virtually zero) hold-up volume.

With minimal dead-volume and available with four porosities, these filters are the best column protectors.

SPECIFICATIONS

MATERIALS

Body 316 SS
Frit PEEK-encased SS

THREADS

10-32 Female for inlet
Male for outlet

PRESSURE RATING

With ZN1 nut and ZF1S6 ferrule:
up to 1375 bar (20,000 psi)

Bore size	Pore size	Internal volume		Product No.
0.13/0.15 mm	0.2 µm	0.59 µL		JR-69230-02
	0.5 µm	0.61 µL		JR-69230-05
	2 µm	0.66 µL		JR-69230-2
	5 µm	0.68 µL		JR-69230-5

Replacement PEEK-encased SS frits

	Pore size	Frit volume	Product No.
(Package/5)	0.2 µm	0.11 µL	JR-1110-02P-5
	0.5 µm	0.13 µL	JR-1110-05P-5
	2 µm	0.18 µL	JR-1110-2P-5
	5 µm	0.20 µL	JR-1110-5P-5





Stainless steel in-line filter

UHPLC

SPECIFICATIONS

MATERIALS

Body 316 SS
Frit PEEK-encased SS

BORE

0.25 or 0.75 mm

THREADS

10-32 female to 10-32 male

PRESSURE RATING

With ZN1 nut and ZF1S6
ferrule:
up to 1375 bar (20,000 psi)

- (U)HPLC
- Minimized hold-up volume
- Two bores for analytical and semi-prep flow rates
- Four porosity options



The stainless steel in-line filter has virtually no hold-up volume and can be used in various applications without significant band broadening or loss of efficiency.

The 0.25 mm bore versions are intended for analytical use between autosampler/injection valve and column. The 0.75 mm bore versions are suitable for higher flow rates in semi-prep systems or for solvent supply from pump to autosampler.

With minimal dead volume and available frit porosities of 0.2, 0.5, 2 or 5 μm , these in-line filters are the ideal column protectors.

Sold individually.

Bore size	Pore size	Internal volume	Product No.
0.25 mm	0.2 μm	0.2 μL	JR-68230-02
	0.5 μm	0.2 μL	JR-68230-05
	2 μm	0.3 μL	JR-68230-2
	5 μm	0.3 μL	JR-68230-5
0.75 mm	0.5 μm	1.7 μL	JR-68231-05
	2 μm	1.9 μL	JR-68231-2
	5 μm	1.9 μL	JR-68231-5

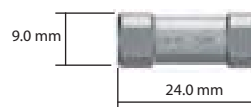

Replacement PEEK-encased SS frits

FOR FILTER ABOVE

(Package/5)	Bore size	Pore size	Frit volume	Product No.
	0.25 mm	0.2 μm	0.11 μL	JR-1110-02P-5
		0.5 μm	0.13 μL	JR-1110-05P-5
		2 μm	0.18 μL	JR-1110-2P-5
		5 μm	0.20 μL	JR-1110-5P-5
	0.75 mm	0.5 μm	0.55 μL	JR-1111-05P-5
		2 μm	0.74 μL	JR-1111-2P-5
		5 μm	0.80 μL	JR-1111-5P-5
		10 μm	0.87 μL	JR-1111-10P-5



NOTES

* The internal volume is the hold-up volume between the end of the connecting tube and the filter 10-32 connector outlet, including the frit volume.

SAFETY PRODUCTS



AND MOBILE PHASE HANDLING SYSTEMS

- Save cost on solvents
- Avoid hazardous air (evaporation) in the laboratories
- Increase reproducibility of chromatographic analyses

VICI strives to provide customers with the best solutions for their problems, making the work better and/or easier with respect to environment and health.

SAFETY PRODUCTS INDEX

VICI SAFETY FILTERS

Air inlet valves	page 67
Air outlet valve	67
Exhaust filters	68-69
Exhaust filter kits NEW	68

SPECIAL APPLICATION FILTERS

Carbon dioxide filter	85
Humidity filter	85

CAPS

Safety cap kits NEW	70
Safety caps	70-71
DIN50 and GL45 threads	
VICI cap kits	74
VICI caps	72-73
GL38, DIN50, GL45, and S40 threads	
Waste caps	76-79
GL45, B53, B83, GLS80, DIN60, S51, and S61 threads	
Multi caps NEW	80-82
GL38, GL45, DIN50, S51, B53, DIN60, S61, GLS80, and B83 threads	
Eco cap	83
Eco cap kit	83

SAFETY-COATED GLASS BOTTLES 84

SOLVIFLEX TUBING 84

Flexible coiled PFA tubing expands and contracts, giving flexibility to move mobile phase bottles on the bench.



Safety air inlet valves

SPECIFICATIONS	
CONNECTIONS	
Valve to cap	1/4-28
Filter	Female Luer
MATERIALS	
Housing	PP (Polypropylene)
Filter	Cellulose
O-ring	NBR (O-ring is not a wetted part)

- No evaporation of volatile compounds into lab air
- Better composition stability of the mobile phases
- Less shift of retention times
- No bacterial contamination
- Fit any VICI cap or VICI safety cap



The air inlet valve has a check valve which blocks vapors of the solution in a bottle, preventing the vapors from escaping into the lab. The mobile phase composition remains stable, resulting in constant retention times.

The check valve regulates the pressure when the negative pressure reaches 1.5 psi or 0.1 bar. This small negative pressure prevents evaporation of the liquid (lower vapor pressure) and still guarantees the stability of the flow rate. A negative pressure which is too high can influence the aspiration of a constant flow.

Several tests have indicated that the 0.2 µm cellulose filter will keep mobile phase free of bacteria and dust particles over time. If you use a filter and still have bacteria growth in your liquid, it is likely due to the presence of bacteria in the deionized water used.

Air inlet valves fit on any VICI safety cap or VICI cap.

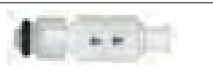

Description		Product No.
With 4 mm filter		JR-S-20003
With 15 mm filter		JR-S-20009
Without filter		JR-S-20006
Spare parts		
Replacement cellulose filter	0.2 µm x 4 mm	JR-S-20007
	0.2 µm x 15 mm	JR-S-20008



TECH TIPS

- The air inlet valve is not suitable when helium sparging is used.
- We recommend that safety air inlet valves and safety air outlet valves be replaced every 6-7 months to guarantee correct operation of the check valve. The lifetime of the check valve and the filter depend on the intensity of use and the quality of the ambient air.

SEE ALSO

Safety caps 70-71
VICI caps 72-74

Safety air outlet valves

The VICI safety air outlet valve regulates the pressure during helium sparging.

Air outlet filters fit on any VICI safety cap or VICI cap.

Description	Product No.
Safety air outlet filter	JR-S-20004



SPECIFICATIONS	
CONNECTIONS	
Valve to cap	1/4-28
Filter	Female Luer
MATERIALS	
Housing	PP (Polypropylene)
Filter	Cellulose
O-ring	NBR (O-ring is not a wetted part)



SAFETY EXHAUST FILTERS

- Prevents ambient air pollution
- Large capacity and long lifetime
- Break-through detector available, alerting users to saturation of the filter absorbent
- Universal 1/4-28 connection – fits all VICI safety caps and VICI caps
- Adapter to competitor products available

Our improved exhaust filter is the center of the VICI Jour safety program, ridding ambient air of solvent vapors which could adversely affect the health of lab workers. When placed on the waste bottle of an HPLC system, the specially-treated absorbent filters out nearly all organic solvent vapor evaporating out of the waste solution.

With 65 g of absorbent, our filters have a larger capacity than competing brands. Typical lifetime is up to 10 months* for methanol and 8 months* for acetonitrile.

The optional **NEW** break-through detector recognizes trace amounts of acetone, acetonitrile, aliphatic and aromatic hydrocarbons, ethanol, ethyl acetate, methanol, methylene chloride and THF.

When the absorbent is saturated, break-through is indicated by a color change in the detector from orange/pink to red. A small charcoal filter absorbs the vapors after they pass the detector.

*Based on results of our tests (water/organics = 50/50; flow rate 1.0 ml/min during the day, 0.5 ml/min overnight, 0.1 ml/min during weekends).



We highly recommend using the exhaust filter with a breakthrough detector!

Safety exhaust filters

1/4-28

SPECIFICATIONS	
CONNECTIONS	
1/4-28	
MATERIALS	
Filter housing	POM
Detector housing	PC
Frits	Polyethylene
O-ring	NBR (O-ring is not a wetted part)

Description		Product No.
Exhaust filter	With breakthrough detector	JR-S-20005
	Without detector	JR-S-20002
Adapter *		JR-S-40004

* Connects VICI safety exhaust filter to SCAT® waste caps and A.I.T. smart waste caps



NEW Replacement exhaust filter kits

1/4-28

Includes three exhaust filters, three breakthrough detectors (if ordered), and a carrying case.

Description	Product No.
Exhaust filter kit	JR-S-35

Kit includes:	Qty	Product No.
Exhaust filters with breakthrough detectors	3	JR-S-20005
Carrying case	1	JR-S-35L

Description	Product No.
Exhaust filter kit without detectors	JR-S-36

Kit includes:	Qty	Product No.
Exhaust filters without breakthrough detectors	3	JR-S-20002
Carrying case	1	JR-S-35L



NOTE

Disposal of the saturated filters must be done according to the local regulations for chemical waste.

TECH TIPS

- Larger capacity = longer lifetime = lower costs
- As a general rule, halving the flow rate doubles the lifetime at constant composition and temperature. Doubling the flow rate halves it.

SEE ALSO

- Carbon dioxide filter... 85
- Humidity filter..... 85
- Safety caps.....70-71
- VICI caps.....72-74

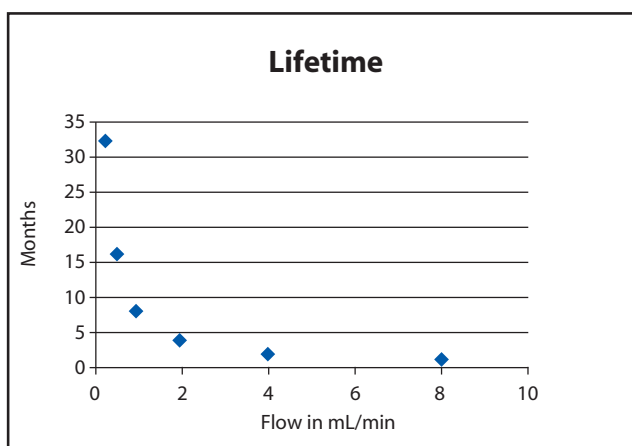
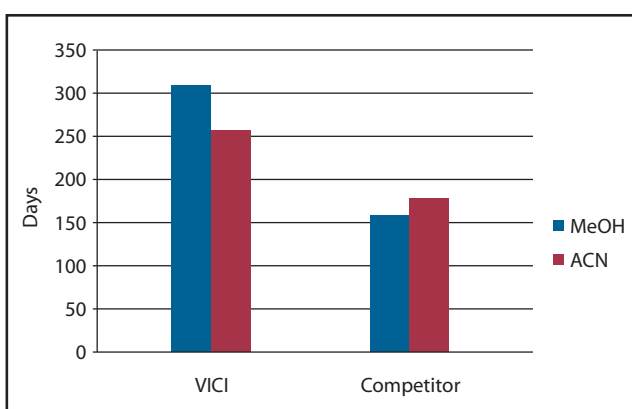
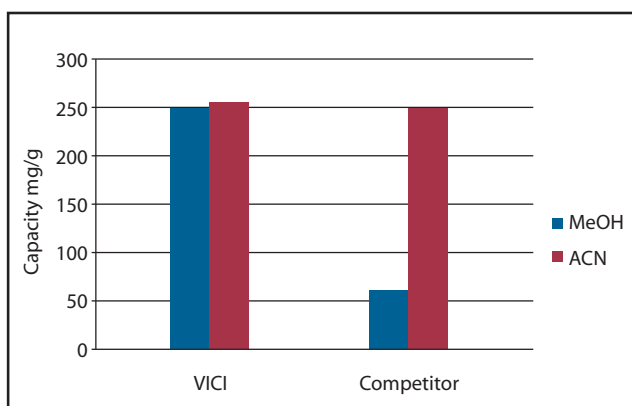

OPTIMIZED ADSORBENT OF SAFETY EXHAUST FILTERS

In our continuous work to improve our products, VICI has optimized the adsorbent for increased capacity. Each detector contains 65 g of adsorbent which guarantees a prolonged life time of the VICI exhaust filter.

The excellent capacity of our new adsorbent leads to longer lifetimes – up to 10 months for methanol and 8 months for acetonitrile.*

*Based on results of our tests (water/organics = 50/50; flow rate 1.0 ml/min during the day, 0.5 ml/min overnight, 0.1 ml/min during weekends).

SAFETY EXHAUST FILTER LIFETIME

The lifetime of the filter depends on:

- Composition of the mobile phase
- Flow rate
- Ambient temperature: higher temperature leads to increased vapor pressure of the volatile compound

The theoretical lifetime of an exhaust filter, depending on the flow rate, is shown in the chart at left.

TECH TIP

Acetonitrile and water form an "azeotropic" mixture at 85% acetonitrile. Due to this physical property, the vapor of an acetonitrile/water mixture always corresponds to the 85/15 mixture. This explains the non-linearity of the lifetime for acetonitrile compared to methanol.

ADDITIONAL APPLICATIONS

Other applications for safety filters are possible, e.g. an exhaust filter for the GC split vent.

For more information, contact Tech Support – support@vici.ch.



SAFETY CAPS

Safety caps have built-in stopcocks to close off unused ports or to provide a convenient cut off of the liquid stream when tubing is removed.

- Stopcocks rated up to 72 psi gas at 25°C
- Prevent evaporation of volatile compounds
- Ideal for delivery of mobile phase or collection of waste LC solutions
- 2, 3, or 4 ports with 1/4-28 threads for 1/8" or 1/16" tubing
- Optional bottom-sealing barbed adapter to connect 1/8" (3.2 mm) ID tubing (shown at right – order separately from "Spare Parts"; page 71)



Safety cap / bottle kit

INCLUDES

- 1 safety cap, GL45 thread, with fittings
- 1 safety-coated glass bottle (1L or 2L)
- 3 m, PFA tubing
- 1 No-Met mobile phase filter, 20 µm
- Additional nuts and ferrules for the bottom side connections

In addition to a GL45 safety cap with color-coded fittings, this kit offers a safety bottle (1 or 2 liter), PFA tubing, and a mobile phase filter.

GL45 safety caps seal to the bottle with an O-ring* (EPDM) which is resistant to commonly used HPLC solvents. If improved chemical resistance is required (e.g. for halogenated hydrocarbons), order an FEP-coated O-ring separately.

Bottle size:	No. of ports	1 Liter	2 Liters
		Product No.	Product No.
Safety cap kit, GL45	2	JR-S-11111	JR-S-11211
	3	JR-S-11112	JR-S-11212
	4	JR-S-11113	JR-S-11213

Product No.

For improved chemical resistance, order:

O-ring, FEP-coated, GL45	JR-S-40008
--------------------------	------------



GL45 THREADS

SPECIFICATIONS

CONNECTIONS

1/4-28

MATERIALS

Closure	PP (Polypropylene)
Insert	PTFE
Stopcock	PCTFE
O-ring	EPDM (optional FEP-coated)
Nuts	PPS
Ferrules	ETFE
Sleeves	PP
Bottle	Borosilicate 3.3, safety coated
Filter	Polyethylene

Spare parts

FOR SAFETY CAP/BOTTLE KITS

		Qty/pkg	Product No.
1/4-28 flangeless nuts	PPS	1/16" OD	10 JR-55070-10
		1/8" OD	10 JR-55071-10
Inverted ferrules	ETFE	1/16" OD	10 JR-041-10
		1/8" OD	10 JR-051-10
Safety-coated bottle with solid cap	1 Liter	1	JR-9000-0005
	2 Liters	1	JR-9000-0010
Plug, 1/4-28, PEEK		1	JR-409
Barbed hose adapter for 1/8" ID tubing		1	JR-075013
Color-Sleeve adapters, 12 colors (2 each)		24	JR-5508X-24
No-Met biocompatible mobile phase filter, economy slip-on connection, 20 µm pore		1	JR-32174
PFA tubing, 1/8" x 1.59 mm x 3m		1	JR-T-4003-M3

➔ MORE INFO

Spare parts for
Safety caps and kits . . 71
Chemical resistance . . 110

t TECH TIP

PFA tubing provides less re-gassing of the mobile phase.

➔ SEE ALSO

Color-Sleeve adapters 23



No-Met mobile phase filters 59
PFA tubing 13
Safety-coated bottles (for additional sizes) . 84
Safety air inlet valves . . 67



Safety cap

GL45 THREADS

SPECIFICATIONS	
CONNECTIONS	
1/4-28	
MATERIALS	
Closure	PP (Polypropylene)
Insert	PTFE
Stopcock	PCTFE
O-ring	EPDM (optional FEP-coated)
Nuts	PPS
Ferrules	ETFE
Sleeves	PP



- Fits all bottles or canisters with GL45 thread
- Built-in stopcocks for easy interruption of solvent lines
- 2, 3, or 4 ports with 1/4-28 threads for 1/8" or 1/16" tubing

GL45 safety caps seal to the bottle with an O-ring* (EPDM) which is resistant to commonly used HPLC solvents.

	No. of ports	Product No.
Safety cap, GL45	2	JR-S-11011
	3	JR-S-11012
	4	JR-S-11013

If improved chemical resistance is required (such as for halogenated hydrocarbons), we offer an FEP-coated O-ring. Order separately.

	Product No.
For improved chemical resistance, order:	
O-ring, FEP-coated, GL45	JR-S-40008

INCLUDES

- 1 cap, GL45 thread, with stopcocks
- 1 O-ring, EPDM
- 1 set: 1/16" nut/ferrule/color-sleeve adapter
- 1, 2, or 3 sets: 1/8" nut/ferrule/color-sleeve adapter
- Additional nuts and ferrules for the bottom side connections

Safety cap

DIN50 THREADS

SPECIFICATIONS	
CONNECTIONS	
1/4-28	
MATERIALS	
Closure	PP (Polypropylene)
Insert	PTFE
Stopcock	PCTFE
O-ring	EPDM/NBR
Nuts	PPS
Ferrules	ETFE
Sleeves	PP



- Fits all bottles or canisters with DIN50 thread
- Built-in stopcocks for easy interruption of solvent lines
- 2, 3, or 4 ports with 1/4-28 threads for 1/8" or 1/16" tubing

DIN50 safety caps seal to the bottle/canister with an O-ring behind a PTFE lip, so the O-ring is therefore not a wetted part.

	No. of ports	Product No.
Safety cap, DIN50	2	JR-S-15011
	3	JR-S-15012
	4	JR-S-15013

INCLUDES

- 1 cap, DIN50 thread, with stopcocks
- 1 O-ring,
- 1 set: 1/16" nut/ ferrule/ color-sleeve adapter
- 1, 2, or 3 sets: 1/8" nut/ferrule/color-sleeve adapter
- Additional nuts and ferrules for the bottom side connections

Spare parts

FOR SAFETY CAPS

		Qty/pkg	Product No.
1/4-28 flangeless nuts	PPS	1/16" OD	JR-55070-10
		1/8" OD	JR-55071-10
Inverted ferrules	ETFE	1/16" OD	JR-041-10
		1/8" OD	JR-051-10
Barbed hose adapter for 1/8" ID tubing		1	JR-075013
Color-Sleeve adapters, 12 colors (2 each)		24	JR-5508X-24
PFA tubing, 1/8" x 1.59 mm x 3m		1	JR-T-4003-M3

NOTE

One port must be reserved for the exhaust filter or the air inlet valve.

SEE ALSO

Air inlet valves..... 67
Exhaust filters 68-69



VICI CAP KITS

HPLC systems use up to 4 different mobile phases. We offer two safety cap kits for use with (up to quaternary) gradient HPLC systems.

NEW VICI cap kit

GL45 THREADS

INCLUDES

- 4 VICI caps, 3 ports, GL45 thread, with fittings
- 4 Air inlet valves with 4 mm filters
- 4 PP plugs
- Carrying case

Description	Product No.
VICI cap kit	JR-S-31

Kit includes:	Qty	Product No.
VICI caps, GL45, three ports	4	JR-S-11002
Air inlet valves with 4 mm filters	4	JR-S-20003
PP plugs	4	JR-201999
Carrying case	1	JR-S-31L

SPECIFICATIONS

CONNECTIONS

1/4-28

MATERIALS

Closure	PP (Polypropylene)
Insert	PTFE
O-ring	EPDM
Nuts	PPS
Ferrules	ETFE
Sleeves	PP
Filter	Polyethylene



NEW VICI cap kit

GL45 THREADS

INCLUDES

- 3 VICI caps, 2 ports, GL45 thread, with fittings
- 1 VICI cap, 3 ports, GL45 thread, with fittings
- 4 Air inlet valves with 4 mm filters
- 1 PP plug
- Carrying case

Description	Product No.
VICI cap kit	JR-S-32

Kit includes:	Qty	Product No.
VICI caps, GL45, two ports	3	JR-S-11001
VICI cap, GL45, three ports	1	JR-S-11002
Air inlet valves with 4 mm filters	4	JR-S-20003
PP plug	1	JR-201999
Carrying case	1	JR-S-31L

SPECIFICATIONS

CONNECTIONS

1/4-28

MATERIALS

Closure	PP (Polypropylene)
Insert	PTFE
O-ring	EPDM
Nuts	PPS
Ferrules	ETFE
Sleeves	PP
Filter	Polyethylene





VICI CAPS

VICI caps seal to the bottle with an O-ring which is resistant to commonly used HPLC solvents. Unused ports should be closed with plugs, available in PEEK or polypropylene.

- Prevent evaporation of volatile compounds
- 2, 3, or 4 ports with 1/4-28 threads for 1/8" or 1/16" tubing
- 6 or 7 ports available in some models
- Optional barbed adapter JR-075013 to connect 1/8" (3.2 mm) ID tubing (order from "Spare Parts", page 75).



VICI cap / bottle kit

GL45 THREADS

INCLUDES

- 1 VICI cap, GL45 thread, with fittings
- 1 safety-coated glass bottle (option: 1L or 2L)
- 3 m, PFA tubing
- 1 No-Met mobile phase filter, 20 µm

In addition to a GL45 VICI cap with fittings, this kit includes a safety bottle (1 or 2 liter), PFA tubing, and a mobile phase filter.

Bottle size:	1 Liter		2 Liters	
	No. of ports	Product No.	Product No.	Product No.
VICI cap kit, GL45	2	JR-S-11101	JR-S-11201	
	3	JR-S-11102	JR-S-11202	
	4	JR-S-11103	JR-S-11203	

Product No.

For improved chemical resistance, order:

O-ring, FEP-coated, GL45	JR-S-40008
--------------------------	------------



SPECIFICATIONS

CONNECTIONS

1/4-28

MATERIALS

Closure	PP (Polypropylene)
Insert	PTFE
O-ring	EPDM (optional FEP-coated)
Nuts	PPS
Ferrules	ETFE
Sleeves	PP
Bottle	Borosilicate 3.3, safety coated
Filter	Polyethylene

VICI cap

GL45 THREADS

INCLUDES

- 1 cap, GL45 thread
- 1 O-ring, EPDM
- 1 set: 1/16" nut/ferrule/ color-sleeve adapter
- 1, 2, 3, 5, or 6 sets: 1/8" nut/ferrule/ color-sleeve adapter

- Fits all bottles or canisters with GL45 thread
 - 2, 3, 4, 6, and 7 ports with 1/4-28 threads for 1/8" or 1/16" tubing
- GL45 safety caps seal the bottle with an O-ring behind a PTFE lip; therefore the O-ring is not a wetted part. If improved chemical resistance is required (e.g. for halogenated hydrocarbons), order an FEP-coated O-ring separately.

VICI cap, GL45	No. of ports		Product No.	
	No. of ports	Product No.	Product No.	Product No.
VICI cap, GL45	2	JR-S-11001		
	3	JR-S-11002		
	4	JR-S-11003		
	6	JR-S-11005		
	7	JR-S-11006		

For improved chemical resistance, order:

O-ring, FEP-coated, GL45	JR-S-40008
--------------------------	------------



6 port 7 port
PTFE CAP INSERTS

SPECIFICATIONS

CONNECTIONS

1/4-28

MATERIALS

Closure	PP (Polypropylene)
Insert	PTFE
O-ring	EPDM (optional FEP-coated)
Nuts	PPS
Ferrules	ETFE
Sleeves	PP

MORE INFO

Spare parts for
VICI caps and kits 75
Chemical resistance . . 110

TECH TIP

PFA tubing provides less re-gassing of the mobile phase.



VICI cap

S40 THREADS

INCLUDES

- 1 cap, S40 thread
- 1 set: 1/16" nut/ ferrule/ color-sleeve adapter
- 2 sets: 1/8" nut/ferrule/ color-sleeve adapter



- Fits all bottles with S40 thread
- 3 ports with 1/4-28 threads for 1/8" or 1/16" tubing

The latest addition to the Jour Safety product line, the S40 VICI cap seals to the bottle with an O-ring (EPDM) which is resistant to commonly used HPLC solvents.

No. of ports Product No.

VICI cap, S40	3	JR-S-14002
---------------	---	------------

SPECIFICATIONS

CONNECTIONS

1/4-28

MATERIALS

Closure	PP* (Polypropylene)
Insert	PTFE
O-ring	EPDM
Nuts	PPS*
Ferrules	ETFE
Sleeves	PP*

*not a wetted part

VICI cap

DIN50 THREADS

INCLUDES

- 1 cap, DIN50 thread
- 1 O-ring,
- 1 set: 1/16" nut/ ferrule/ color-sleeve adapter
- 1, 2, or 3 sets: 1/8" nut/ferrule/ color-sleeve adapter



- Fits all bottles or canisters with DIN50 thread
- 2, 3, or 4 ports with 1/4-28 threads for 1/8" or 1/16" tubing

DIN50 VICI caps seal to the bottle/canister with an O-ring behind a PTFE lip, so the O-ring is therefore not a wetted part.

No. of ports Product No.

VICI cap, DIN50	2	JR-S-15001
	3	JR-S-15002
	4	JR-S-15003



SPECIFICATIONS

CONNECTIONS

1/4-28

MATERIALS

Closure	PP (Polypropylene)
Insert	PTFE
O-ring	EPDM/NBR
Nuts	PPS
Ferrules	ETFE
Sleeves	PP

VICI cap

GL38 THREADS

INCLUDES

- 1 cap, GL38/430 thread
- 1 O-ring
- 1 set: 1/16" nut/ ferrule/ color-sleeve adapter
- 1, 2, or 3 sets: 1/8" nut/ferrule/ color-sleeve adapter
- 1 adapter ring



- Fits all bottles or canisters with GL38/430 thread (See NOTES, below right)
- 2, 3, or 4 ports with 1/4-28 threads for 1/8" or 1/16" tubing

Color-coded PP sleeves fit on all ports on 2 and 3 port caps. With 4 port caps, the use of PP sleeves is limited to two sleeves per cap. (Four colors are included.)

No. of ports Product No.

VICI cap, GL38	2	JR-S-13001
	3	JR-S-13002
	4	JR-S-13003

Product No.

For improved chemical resistance, order:

O-ring, FEP-coated, GL45	JR-S-40009
--------------------------	------------

SPECIFICATIONS

CONNECTIONS

1/4-28

MATERIALS

Closure	PP (Polypropylene)
Insert	PTFE
O-ring	EPDM (optional FEP-coated)
Adapter ring	PA/PP
Nuts	PPS
Ferrules	ETFE
Sleeves	PP

i GL38 NOTES

GL38 thread is available in different variations. Please check the inside diameter of the neck:

- For 21-24 mm ID (e.g. Wheaton® bottles), use the GL38 cap as is, without an adapter.
- For 24-28 mm ID (e.g. Nalgene® bottles), use the adapter ring (JR-S-40006) which is included with this VICI cap.

**Spare parts****FOR VICI CAP/BOTTLE KITS**

		<i>Qty/pkg</i>	<i>Product No.</i>
Safety-coated bottle with solid cap	1 Liter	1	JR-9000-0005
	2 Liters	1	JR-9000-0010
No-Met biocompatible mobile phase filter, economy slip-on connection, 5 µm pore		1	JR-32174
PFA tubing, 1/8" x 1.59 mm x 3m		1	JR-T-4003-M3

Spare parts**FOR VICI CAPS**

		<i>Qty/pkg</i>	<i>Product No.</i>
1/4-28 flangeless nuts	PPS	1/16" OD	10 JR-55070-10
		1/8" OD	10 JR-55071-10
Inverted ferrules	ETFE	1/16" OD	10 JR-041-10
		1/8" OD	10 JR-051-10
Plug, 1/4-28	PEEK	1	JR-409
	Polypropylene	1	JR-201999
Barbed hose adapter for 1/8" ID tubing		1	JR-075013
Color-Sleeve adapters, 12 colors (2 each)		24	JR-5508X-24

SEE ALSO

Color-Sleeve adapters . 23
 No-Met mobile
 phase filters 59
 PFA tubing 13
 Safety-coated bottles
 (for additional sizes) . 84
 Safety air inlet valves . . 67



WASTE CAPS

Waste caps seal the bottle/canister with an O-ring behind a PTFE lip; therefore the O-ring is not a wetted part. Unused ports should be closed with plugs, available in PEEK or polypropylene.

- Prevent evaporation of volatile compounds
- 3 or 4 ports with 1/4-28 threads for 1/8" or 1/16" tubing
- Additional port with 1/2-20 thread for 1/4" OD tubing or M10 x 1 thread for a barbed adapter
- Thread-sealing barbed adapters available in three sizes, to connect 4 mm, 6 mm, or 8 mm ID tubing (shown at right – order separately from "Spare Parts" on page 79)



i NOTE

One port must be reserved for the exhaust filter or the air inlet valve.

Waste cap

GL45 THREADS

INCLUDES

- 1 cap
- 1 O-ring
- 1 set: 1/16" nut/ ferrule/ color-sleeve adapter
- 2 sets: 1/8" nut/ferrule/ color-sleeve adapter

- Fits all bottles or canisters with GL45 thread
 - 4 ports with with one M10 x 1 port for barbed/angled adapters
- This waste cap seals the bottle/cannester with an O-ring behind a PTFE lip, so the O-ring is therefore not a wetted part.



Product No.

Waste cap, GL45		
Fourth port:	1/2-20 thread for 1/4" OD tubing, with 1/4" plug	JR-S-11003W
	M10 x 1 thread for barbed adapter	JR-S-11023

SPECIFICATIONS

CONNECTIONS

1/4-28, 1/2-20

MATERIALS

Closure	PP (Polypropylene)
Insert	PTFE
O-ring	NBR
Nuts	PPS/POM
Ferrules	ETFE/CTFE
Plug	PTFE
Barbed adapter	PA/PP

Waste cap

GLS80 THREADS

INCLUDES

- 1 cap
- 1 O-ring
- 1 set: 1/16" nut/ ferrule/ color-sleeve adapter
- 1 set: 1/4" nut/ferrule
- 3 sets: 1/8" nut/ferrule/ color-sleeve adapter
- 1 plug, 1/4" (1/2-20), where noted in product number chart

- Fits all bottles or canisters with GLS80 thread
- 4 ports with 1/4-28 thread for 1/8" or 1/16" tubing
- Fifth port with choice of threads

Product No.

Waste cap, GLS80		
Fifth port:	1/2-20 thread for 1/4" OD tubing, with 1/4" plug	JR-S-18004
	M10 x 1 thread for barbed adapter *	JR-S-18014

* Order barbed adapter separately, bottom of page 79



SPECIFICATIONS

CONNECTIONS

1/4-28, 1/2-20

MATERIALS

Closure	PP (Polypropylene)
Insert	PTFE
O-ring	NBR
Nuts	PPS/POM
Ferrules	ETFE/CTFE
Plug	PTFE
Barbed adapter	PA/PP

➔ MORE INFO

Spare parts for waste caps 79
Chemical resistance .. 110

➔ SEE ALSO

Waste caps
B53 threads 78
B83 threads 78



Waste cap

DIN60 THREADS

SPECIFICATIONS	
CONNECTIONS	
1/4-28, 1/2-20	
MATERIALS	
Closure	PE (Polyethylene)
Insert	PTFE
O-ring	NBR
Nuts	PPS/POM
Ferrules	ETFE/CTFE
Plug	PTFE
Barbed adapter	PA/PP



- Fits all bottles or canisters with DIN60 thread
- 3 ports with 1/4-28 thread for 1/8" or 1/16" tubing
- Fourth port with choice of threads

Product No.

Waste cap, DIN60		
Fourth port:	1/2-20 thread for 1/4" OD tubing, with 1/4" plug	JR-S-16003
	M10 x 1 thread for barbed adapter *	JR-S-16013

* Order barbed adapter separately, bottom of page 79

INCLUDES

- 1 cap
- 1 O-ring
- 1 set: 1/16" nut/ ferrule/ color-sleeve adapter
- 1 set: 1/4" nut/ferrule
- 2 sets: 1/8" nut/ferrule/ color-sleeve adapter
- 1 plug, 1/4" (1/2-20), where noted in product number chart

Waste cap

S51 THREADS

SPECIFICATIONS	
CONNECTIONS	
1/4-28, 1/2-20	
MATERIALS	
Closure	PE (Polyethylene)
Insert	PTFE
O-ring	NBR
Nuts	PPS/POM
Ferrules	ETFE/CTFE
Plug	PTFE
Barbed adapter	PA/PP



- Fits all bottles or canisters with S51 thread
- 3 ports with 1/4-28 thread for 1/8" or 1/16" tubing
- Fourth port with choice of threads

Product No.

Waste cap, S51		
Fourth port:	1/2-20 thread for 1/4" OD tubing, with 1/4" plug	JR-S-15103
	M10 x 1 thread for barbed adapter *	JR-S-15113

* Order barbed adapter separately, bottom of page 79

INCLUDES

- 1 cap
- 1 O-ring
- 1 set: 1/16" nut/ ferrule/ color-sleeve adapter
- 1 set: 1/4" nut/ferrule
- 2 sets: 1/8" nut/ferrule/ color-sleeve adapter
- 1 plug, 1/4" (1/2-20), where noted in product number chart

Waste cap

S61 THREADS

SPECIFICATIONS	
CONNECTIONS	
1/4-28, 1/2-20	
MATERIALS	
Closure	PE (Polyethylene)
Insert	PTFE
O-ring	NBR
Nuts	PPS/POM
Ferrules	ETFE/CTFE
Plug	PTFE
Barbed adapter	PA/PP



- Fits all bottles or canisters with S61 thread
- 3 ports with 1/4-28 thread for 1/8" or 1/16" tubing
- Fourth port with choice of threads

Product No.

Waste cap, S61		
Fourth port:	1/2-20 thread for 1/4" OD tubing, with 1/4" plug	JR-S-16103
	M10 x 1 thread for barbed adapter *	JR-S-16113

* Order barbed adapter separately, bottom of page 79

INCLUDES

- 1 cap
- 1 O-ring
- 1 set: 1/16" nut/ ferrule/ color-sleeve adapter
- 1 set: 1/4" nut/ferrule
- 2 sets: 1/8" nut/ferrule/ color-sleeve adapter
- 1 plug, 1/4" (1/2-20), where noted in product number chart

SEE ALSO

- Color-Sleeve adapters. 23
- Exhaust filters 68-69
- Air inlet valves. 67

Waste caps



SAFETY PRODUCTS

Waste cap

B53 THREADS

INCLUDES

- 1 cap
- 1 O-ring
- 1 set: 1/16" nut/ ferrule/ color-sleeve adapter
- 1 set: 1/4" nut/ferrule
- 2 sets: 1/8" nut/ferrule/ color-sleeve adapter
- 1 plug, 1/4" (1/2-20), where noted in product number chart

- Fits all bottles or canisters with B53 thread
- 3 ports with 1/4-28 thread for 1/8" or 1/16" tubing
- Fourth port with choice of threads

Product No.

Waste cap, B53		
Fourth port:	1/2-20 thread for 1/4" OD tubing, with 1/4" plug	JR-S-15303
	M10 x 1 thread for barbed adapter*	JR-S-15313

* Order barbed adapter separately, on the page opposite



SPECIFICATIONS

CONNECTIONS

1/4-28, 1/2-20

MATERIALS

Closure	PP (Polypropylene)
Insert	PTFE
O-ring	NBR
Nuts	PPS/POM
Ferrules	ETFE/CTFE
Plug	PTFE
Barbed adapter	PA/PP

Waste cap

B83 THREADS

INCLUDES

- 1 cap
- 1 O-ring
- 1 set: 1/16" nut/ ferrule/ color-sleeve adapter
- 1 set: 1/4" nut/ferrule
- 3 sets: 1/8" nut/ferrule/ color-sleeve adapter
- 1 plug, 1/4" (1/2-20), where noted in product number chart

- Fits all bottles or canisters with B83 thread
- 4 ports with 1/4-28 thread for 1/8" or 1/16" tubing
- Fifth port with choice of threads

Product No.

Waste cap, B83		
Fifth port:	1/2-20 thread for 1/4" OD tubing, with 1/4" plug	JR-S-18304
	M10 x 1 thread for barbed adapter*	JR-S-18314

* Order barbed adapter separately, on the page opposite



SPECIFICATIONS

CONNECTIONS

1/4-28, 1/2-20

MATERIALS

Closure	PP (Polypropylene)
Insert	PTFE
O-ring	NBR
Nuts	PPS/POM
Ferrules	ETFE/CTFE
Plug	PTFE
Barbed adapter	PA/PP

i NOTE

One port must be reserved for the exhaust filter or the air inlet valve.

➔ MORE INFO

Chemical resistance 96-98

➔ SEE ALSO

Waste caps
 DIN60 threads 77
 GL45 threads 76
 GLS80 threads 76
 S51 threads 77
 S61 threads 77
 Color-Sleeve adapters 23
 Exhaust filters 68-69
 Air inlet valves 67



Spare parts FOR WASTE CAPS

		<i>Qty/pkg</i>		<i>Product No.</i>
1/4-28 flangeless nuts	PPS	1/16" OD	10	JR-55070-10
		1/8" OD	10	JR-55071-10
Inverted ferrules	ETFE	1/16" OD	10	JR-041-10
		1/8" OD	10	JR-051-10
1/2-20 nut	POM	1/4" OD	1	JR-CFL-4D
Collapsible ferrule	CTFE	1/4" OD	1	JR-CFL-CB4KF-S
Plug, 1/4-28	PEEK		1	JR-409
	Polypropylene		1	JR-201999
Plug, 1/2-20	PTFE		1	JR-S-40007
Plug, M10 x 1	PA		1	JR-073001
Barbed hose adapter for 1/8" ID tubing			1	JR-075013
Color-Sleeve adapters, 12 colors (2 each)			24	JR-5508X-24

Tubing size Qty/pkg Product No.

Adapters				
1/2-20 to 1/4-28	POM		10	JR-S-40200
Barbed hose adapter	PA/PP	1/8" ID	1	JR-075013

Tubing size Qty/pkg Product No.

Barbed adapters, M10 x 1				
Angled	PA	4 mm ID	1	JR-S-40104
	PA	6 mm ID	1	JR-S-40106
	PA	8 mm ID	1	JR-S-40108
Straight	PA	4 mm ID	1	JR-S-40304
	PA	6 mm ID	1	JR-S-40306
	PA	8 mm ID	1	JR-S-40308
T	PA	4 mm ID	1	JR-S-40404
	PA	6 mm ID	1	JR-S-40406

NEW Multi caps



SAFETY PRODUCTS

MULTI CAPS

NEW VICI multi caps are available for bottles with GL38, GL45, DIN50, S51, B53, DIN60, S61, GLS80 and B83 threads. They can be used for mobile phase or waste bottles/canisters.

All multi caps come with three angled PA barbed adapters for connecting tubing with 4mm, 6mm and 8mm ID, a PA plug for the M10x1 bore, and PP plugs for the 1/4-28 bores.

Optionally, the caps can be equipped with PA straight and T-adapters for different ID tubing.

NEW Multi cap

GL38 THREADS

INCLUDES

- 1 cap
- 1 O-ring
- 1 set: 1/8" nuts/ferrules/colored sleeve adapters
- 1 set: angled barbed adapters for 4mm, 6mm and 8mm ID tubing
- 1 set: plugs (PA and PP)



- Fits all bottles or canisters with GL38 thread
- 1 port with 1/4-28 thread for 1/8" OD tubing
- Second port with M10x1 threads for barbed adapters

Product No.

Multi cap, GL38	JR-S-13011
-----------------	------------

SPECIFICATIONS

CONNECTIONS

1/4-28, M10 x 1

MATERIALS

Closure	PP/PE
Insert	PTFE
O-ring	NBR
Nuts	PPS/POM
Ferrules	ETFE
Sleeves	PP (1/4-28) PA (M10x 1)

NEW Multi cap

GL45 THREADS

INCLUDES

- 1 cap
- 1 O-ring
- 2 sets: 1/8" nuts/ferrules/colored sleeve adapters
- 1 set: angled barbed adapters for 4mm, 6mm and 8mm ID tubing
- 1 set: plugs (PA and PP)



- Fits all bottles or canisters with GL45 thread
- 2 ports with 1/4-28 thread for 1/8" OD tubing
- Third port with M10x1 threads for barbed adapters

Product No.

Multi cap, GL45	JR-S-11052
-----------------	------------

SPECIFICATIONS

CONNECTIONS

1/4-28, M10 x 1

MATERIALS

Closure	PP/PE
Insert	PTFE
O-ring	NBR
Nuts	PPS/POM
Ferrules	ETFE
Sleeves	PP (1/4-28) PA (M10x 1)

NEW Multi cap

DIN50 THREADS

INCLUDES

- 1 cap
- 1 O-ring
- 2 sets: 1/8" nuts/ferrules/colored sleeve adapters
- 1 set: angled barbed adapters for 4mm, 6mm and 8mm ID tubing
- 1 set: plugs (PA and PP)



- Fits all bottles or canisters with DIN50 thread
- 2 ports with 1/4-28 thread for 1/8" OD tubing
- Third port with M10x1 threads for barbed adapters

Product No.

Multi cap, DIN50	JR-S-15052
------------------	------------

SPECIFICATIONS

CONNECTIONS

1/4-28, M10 x 1

MATERIALS

Closure	PP/PE
Insert	PTFE
O-ring	NBR
Nuts	PPS/POM
Ferrules	ETFE
Barbed adapters	PA
Plugs	PP (1/4"-28) PA (M10x1)



NEW Multi cap

S51 THREADS

SPECIFICATIONS	
CONNECTIONS	
1/4-28, M10 x 1	
MATERIALS	
Closure	PP/PE
Insert	PTFE
O-ring	NBR
Nuts	PPS/POM
Ferrules	ETFE
Barbed adapters	PA
Plugs	PP (1/4"-28) PA (M10x1)



- Fits all bottles or canisters with S51 thread
- 2 ports with 1/4-28 thread for 1/8" OD tubing
- Third port with M10x1 threads for barbed adapters

Product No.

Multi cap, S51	JR-S-15152
----------------	------------

INCLUDES

- 1 cap
- 1 O-ring
- 2 sets: 1/8" nuts/ferrules/colored sleeve adapters
- 1 set: angled barbed adapters for 4mm, 6mm and 8mm ID tubing
- 1 set: plugs (PA and PP)

NEW Multi cap

B53 THREADS

SPECIFICATIONS	
CONNECTIONS	
1/4-28, M10 x 1	
MATERIALS	
Closure	PP/PE
Insert	PTFE
O-ring	NBR
Nuts	PPS/POM
Ferrules	ETFE
Barbed adapters	PA
Plugs	PP (1/4"-28) PA (M10x1)



- Fits all bottles or canisters with B53 thread
- 2 ports with 1/4-28 thread for 1/8" OD tubing
- Third port with M10x1 threads for barbed adapters

Product No.

Multi cap, B53	JR-S-15352
----------------	------------

INCLUDES

- 1 cap
- 1 O-ring
- 2 sets: 1/8" nuts/ferrules/colored sleeve adapters
- 1 set: angled barbed adapters for 4mm, 6mm and 8mm ID tubing
- 1 set: plugs (PA and PP)

NEW Multi cap

DIN60 THREADS

SPECIFICATIONS	
CONNECTIONS	
1/4-28, M10 x 1	
MATERIALS	
Closure	PP/PE
Insert	PTFE
O-ring	NBR
Nuts	PPS/POM
Ferrules	ETFE
Barbed adapters	PA
Plugs	PP (1/4"-28) PA (M10x1)



- Fits all bottles or canisters with DIN60 thread
- 2 ports with 1/4-28 thread for 1/8" OD tubing-
- Third port with M10x1 threads for barbed adapters

Product No.

Multi cap, DIN60	JR-S-16052
------------------	------------

INCLUDES

- 1 cap
- 1 O-ring
- 2 sets: 1/8" nuts/ferrules/colored sleeve adapters
- 1 set: angled barbed adapters for 4mm, 6mm and 8mm ID tubing
- 1 set: plugs (PA and PP)

NEW Multi caps



SAFETY PRODUCTS

NEW Multi cap

S61 THREADS

INCLUDES

- 1 cap
- 1 O-ring
- 2 sets: 1/8" nuts/ ferrules/colored sleeve adapters
- 1 set: angled barbed adapters for 4mm, 6mm and 8mm ID tubing
- 1 set: plugs (PA and PP)



- Fits all bottles or canisters with S61 thread
- 1 port with 1/4-28 thread for 1/8"
- Second port with M10x1 threads for barbed adapters

Product No.

Multi cap, S61	JR-S-16152
----------------	------------

SPECIFICATIONS

CONNECTIONS

1/4-28, M10 x 1

MATERIALS

Closure	PP/PE
Insert	PTFE
O-ring	NBR
Nuts	PPS/POM
Ferrules	ETFE
Barbed adapters	PA
Plugs	PP (1/4"-28) PA (M10x1)

NEW Multi cap

GLS80 THREADS

INCLUDES

- 1 cap
- 1 O-ring
- 2 sets: 1/8" nuts/ ferrules/colored sleeve adapters
- 1 set: angled barbed adapters for 4mm, 6mm and 8mm ID tubing
- 1 set: plugs (PA and PP)



- Fits all bottles or canisters with GLS80 thread
- 2 ports with 1/4-28 thread for 1/8"
- Third port with M10x1 threads for barbed adapters

Product No.

Multi cap, GLS80	JR-S-18053
------------------	------------

SPECIFICATIONS

CONNECTIONS

1/4-28, M10 x 1

MATERIALS

Closure	PP/PE
Insert	PTFE
O-ring	NBR
Nuts	PPS/POM
Ferrules	ETFE
Barbed adapters	PA
Plugs	PP (1/4"-28) PA (M10x1)

NEW Multi cap

B83 THREADS

INCLUDES

- 1 cap
- 1 O-ring
- 2 sets: 1/8" nuts/ ferrules/colored sleeve adapters
- 1 set: angled barbed adapters for 4mm, 6mm and 8mm ID tubing
- 1 set: plugs (PA and PP)



- Fits all bottles or canisters with B83 thread
- 2 ports with 1/4-28 thread for 1/8"
- Third port with M10x1 threads for barbed adapters

Product No.

Multi cap, B83	JR-S-18353
----------------	------------

SPECIFICATIONS

CONNECTIONS

1/4-28, M10 x 1

MATERIALS

Closure	PP/PE
Insert	PTFE
O-ring	NBR
Nuts	PPS/POM
Ferrules	ETFE
Barbed adapters	PA
Plugs	PP (1/4"-28) PA (M10x1)



ECO CAPS

The Eco cap consists of a three-hole ETFE insert (two bores for 1/8" and one for 4 mm OD tubing) with a polyethylene collar, compatible with all standard GL45 thread bottles. The Eco cap has no threading for fittings on the inside of the tubing ports – the tubing is simply inserted.

Eco cap/ safety bottle kit

GL45 THREADS

SPECIFICATIONS

MATERIALS

Screw collar	PP (Polypropylene)
Pouring ring	PP
Insert	ETFE
O-ring	EPDM
Luer plug	PP

In addition to an Eco cap with polypropylene male Luer plug, this kit offers a safety bottle (1 or 2L).

Bottle size Product No.

Eco cap kit	1 Liter	JR-9000-0013
	2 Liter	JR-9000-0014



INCLUDES

- 1 cap, GL45 thread, with three ports
- 1 safety-coated glass bottle (option: 1 L or 2 L)
- 1 male Luer plug, polypropylene, for 4 mm bore
- 3 m PFA tubing
- 1 No-met filter, 20 µm

Eco cap

GL45 THREADS

SPECIFICATIONS

MATERIALS

Screw collar	PP (Polypropylene)
Pouring ring	PP
Insert	ETFE
O-ring	EPDM
Luer plug	PP



- Competitively priced alternative to sparge and deliver mobile phases
- Also available as bottle kit

Product No.

Eco cap	JR-9000-0007
---------	--------------

INCLUDES

- 1 cap, GL45 thread, with three ports
- 1 male Luer plug, polypropylene, for 4 mm bore
- 3 m PFA tubing
- 1 No-met filter, 20 µm

i NOTE

These caps are not usable for building up a helium atmosphere within in the solvent bottle, but only for continuous helium sparging.

t TECH TIP

Once the mobile phase is degassed, we recommend our impermeable tubing between bottle cap and pump to prevent regassing of helium degassed solvents.

➔ SEE ALSO

Impermeable tubing .. 17
Polymeric tubing ... 13-17
Waste caps 76-79

Spare parts

FOR ECO CAP

Qty/pkg Product No.

Male Luer plug, polypropylene	10	JR-070350-10
-------------------------------	----	--------------

SolviFlex • Safety-coated glass bottles



SAFETY PRODUCTS

SolviFlex

INCLUDES

- ~3m coiled 1/8" PFA tubing
- 2 sets: 1/4-28 nut/ ferrules for 1/8" OD tubing
- 1 No-Met mobile phase filter with economy slip-on connection (JR-32174)

- Be "mobile" with mobile phase bottles
- Ideal with VICI safety caps or VICI caps
- Customized version on request

The SolviFlex is made of flexible telephone cable-like PFA tubing which expands and contracts, providing flexibility to move mobile phase bottles up to 1.5 m radius on the bench. Approximately 3 m of tubing is coiled with straight stretches of tubing at each end.

Product No.

SolviFlex assembly	JR-6120-50030
--------------------	---------------



SPECIFICATIONS

TUBING SIZE

1/8 OD

MATERIALS

Tubing	PFA
Nuts	PPS
Ferrules	ETFE
Filter	PE

Safety-coated glass bottles

- Special design for helium sparging of LC mobile phases
- Safety coating to minimize risk of injury
- Available in 0.25, 0.5, 1 and 2 Liter sizes

These glass bottles with GL45 screw threading are made of chemical resistant Borosilicate 3.3 and are coated on the outside with a layer of sturdy polymer, decreasing the chances of breakage if the bottle is dropped. Even if the bottle breaks, glass fragments will be kept within the polymer coating. Solvents will be kept within the coating for a short while. The coating also protects solvents against UV light up to 385 nm.

These safety-coated glass bottles cannot be autoclaved.

Bottles include a solid cap.

Bottle size Product No.

Safety-coated bottle	0.25 L	JR-9000-0011
	0.5 L	JR-9000-0012
	1 L	JR-9000-0005
	2 L	JR-9000-0010



SPECIFICATIONS

PRESSURE RATING

0.8 bar (11.6 psi)

MATERIALS

Bottle	Borosilicate 3.3 glass
Cap	PP
Pouring ring	PP



A TYPICAL USE OF SOLVIFLEX
Shown installed on a VICI cap and bottle, along with an exhaust filter

i NOTES

- The bottles are not suitable to be stressed with pressures above 0.8 bar (11.6 psi), but only for continuous helium sparging.
- The safety coating on a bottle is not intended to replace safe working conditions and precautions in laboratories.

➔ SEE ALSO

No-Met biocompatible mobile phase filter... 59
Safety caps... 70-71
Safety cap kit... 70
Safety exhaust filter 68-69
VICI caps... 72-73
VICI cap kit... 74



Carbon dioxide filter

CO₂

In ion chromatography, a basic solution is often used as mobile phase. Because of their low buffer capacity, the pH of these eluents can easily be affected by the carbon dioxide in the air.

Using a bottle in combination with a VICI cap and a carbon dioxide filter prevents any change in the pH of the mobile phase, thus increasing the stability and reproducibility of the analysis. In this application, the carbon dioxide filter also functions as an air inlet valve.

Product No.

Carbon dioxide filter	JR-S-20100
-----------------------	------------



Humidity filter

H₂O

In applications requiring a non-aqueous organic solvent – chiral separations, for example – traces of moisture in the ambient air can influence the results.

The use of a humidity filter in combination with a VICI cap solves this problem.

Product No.

Humidity filter	JR-S-20200
-----------------	------------

SEE ALSO

Safety
exhaust filters 68-69

FRITS



REPRODUCIBILITY AND PRECISION

VICI Jour unidense frits, with uniform flow across the entire frit, offer unexcelled reproducibility and precision. Proprietary manufacturing processes ensure uniformity and precise, repeatable dimensional control.

PEEK-encased frits surround the frit with a ring of PEEK, reducing the actual porous surface to the ID of an HPLC column or filter.

FRITS INDEX

UNIDENSE FRITS

Stainless.....	page 87
Titanium.....	87
Polyethylene.....	86

PEEK-ENCASED FRITS

Stainless.....	88
Titanium.....	89
Polyethylene.....	89

Polyethylene frits

UNIDENSE TYPE

- Biocompatible
- Metal free

Our completely metal-free polymer frits are made of UHMWPE (Ultra High Molecular Weight PolyEthylene), and offer a competitively priced alternative to titanium.

For single use only. Sold in packages of 5.



SPECIFICATIONS

MATERIAL
UHMWPE
TOLERANCES
±0.08 mm (.003")
PRESSURE RATING
<210 bar (3000 psi)

OD		Thickness		Porosity	Frit volume	Product No.
inches	mm	inches	mm	µm	µL	
.255	6.50	.079	2.00	10	26.5	JR-F-255-079-10PE-5

➔ **OPTIONS AND MORE INFORMATION**

See facing page.

➔ **SEE ALSO**

PEEK-encased polyethylene frits 89



Stainless steel frits

UNIDENSE TYPE

SPECIFICATIONS

MATERIAL
Stainless steel
Type 316L sintered

TOLERANCES
See chart below

For both standard frits and those produced to custom specifications, these frits offer unexcelled reproducibility and precision. Proprietary manufacturing processes ensure uniformity and precise, repeatable dimensional control.

Stainless steel frits are manufactured of SS316L, which has extra-low carbon content. The sintering process used results in a strong bonding of the sinter metal particles. Depending on the grade of powder used, the porosity of the frit can be precisely tuned.

Sold in packages of 5.



OD		Thickness		Porosity	Frit volume	Product No.
inches	mm	inches	mm	µm	µL	
1/16"	1.59	.030	0.76	0.5	0.39	JR-.5FR1-5
				1	0.45	JR-1FR1-5
				2	0.53	JR-2FR1-5
				10	0.60	JR-10FR1-5
1/8"	3.18	.040	1.02	0.5	2.10	JR-.5FR2-5
				1	2.43	JR-1FR2-5
				2	2.83	JR-2FR2-5
				10	3.24	JR-10FR2-5
1/4"	6.35	.040	1.02	0.5	8.39	JR-.5FR4-5
				2	11.30	JR-2FR4-5
				10	12.91	JR-10FR4-5
3/8"	9.53	.040	1.02	0.5	18.91	JR-.5FR6-5
				2	25.45	JR-2FR6-5
				10	29.09	JR-10FR6-5
1/2"	12.70	.040	1.02	0.5	33.58	JR-.5FR8-5
				2	45.2	JR-2FR8-5
				10	51.66	JR-10FR8-5
1"	25.40	.060	1.52	2	269.43	JR-2FR1K-5
				10	307.92	JR-10FR1K-5

➔ OPTIONS

- Standard frits do not have chamfers. Chamfered frits are available on request.
- Other dimensions and porosities are available on request. Minimum order quantity: 100 pieces. Please contact your local distributor or VICI directly.

i TOLERANCES

OD (mm)	Tolerance
<5	±0.05 mm (.002")
5-12	±0.08 mm (.003")
12.5-25.4	±0.20 mm (.008")

i NOTES

- Stated porosities are only nominal and do not reflect the maximum pore size of a frit.
- See frit volume chart for help choosing the right frit and porosity for your application... page 109
- Frit volumes are theoretical and are calculated by multiplying overall frit volume times the porosity proportion.

➔ SEE ALSO

PEEK-encased frits	
Stainless	88
Titanium	89

SPECIFICATIONS

MATERIAL
Titanium, sintered

TOLERANCES
See chart at left

Titanium frits

UNIDENSE TYPE

- Biocompatible
- Recommended for protein analysis
- High corrosion resistance
- Various pore sizes and diameters

Titanium is preferred over stainless steel for applications related to the analysis of sensitive substances in general and large biomolecules in particular. Evidently proteins have a tendency to adsorb on the stainless steel (iron) frit and consequently reduce recovery or may even decompose. Titanium also offers higher corrosion resistance and can be used with solvents containing halides.

Sold in packages of 5.



OD		Thickness		Porosity	Frit volume	Product No.
inches	mm	inches	mm	µm	µL	
1/16"	1.59	.062	1.57	0.5	0.82	JR-.5FR1TI-5
		.040	1.02	2	0.71	JR-2FR1TI-5
1/8"	3.18	.040	1.02	2	2.83	JR-2FR2TI-5
1/4"	6.35	.040	1.02	2	11.30	JR-2FR4TI-5
3/8"	9.53	.040	1.02	2	25.45	JR-2FR6TI-5
1/2"	12.70	.040	1.02	2	45.2	JR-2FR8TI-5
				10	51.66	JR-10FR8TI-5
1"	25.40	.040	1.02	2	180.80	JR-2FR1KTI-5



PEEK-ENCASED FRITS

PEEK-encased frits surround the frit with a ring of PEEK, reducing the actual porous surface to the ID of an HPLC column or filter.

The compressed PEEK ring forms a seal between the bottom of the fitting and the column end, preventing the mobile phase and the sample from entering the previously accessible poorly swept areas.

Stainless steel frits

PEEK-ENCASED

- For HPLC columns or in-line filters
- Eliminate poorly swept volume and improves peak symmetry
- Various porosity and dimension options

Our PEEK-encased frits with 0.115" or 1/4" OD ring are intended for HPLC columns with IDs of 3.2, 3.9, and 4.6 mm. With the frit surrounded by a PEEK ring, the actual porous surface is reduced to the column ID.

The compressed PEEK ring forms a seal between the bottom of the fitting and the column end, preventing the mobile phase and the sample from entering the previously accessible poorly swept areas.

Sold in packages of 5.

Ring OD		Frit OD		Thickness		Porosity	Frit volume	Product No.
inches	mm	inches	mm	inches	mm	μm	μL	
.115"	2.92	.038	0.97	.028	0.70	0.5	0.13	JR-1110-05P-5
						2	0.18	JR-1110-2P-5
						5	0.20	JR-1110-5P-5
		.077	1.96	.028	0.70	0.5	.055	JR-1111-05P-5
						2	0.74	JR-1111-2P-5
						5	0.80	JR-1111-5P-5
.25"	6.35	.078	2.00	.062	1.59	0.5	1.30	JR-1104-05P-5
						2	1.74	JR-1104-2P-5
		.125	3.20	.062	1.59	0.5	3.32	JR-1102-05P-5
						2	4.47	JR-1102-2P-5
		.153	3.90	.062	1.59	0.5	4.94	JR-1101-05P-5
						2	4.47	JR-1101-2P-5
		.181	4.60	.062	1.59	0.5	6.87	JR-1100-05P-5
						2	9.24	JR-1100-2P-5
		.125	3.20	.032	0.80	0.5	1.75	JR-1103-05P-5
						2	2.25	JR-1103-2P-5



SPECIFICATIONS

MATERIAL

Frit Stainless S316L

Ring PEEK

TOLERANCES

±0.05 mm (.002")

SEE OPTIONS

Other dimensions and porosities are available on request. Minimum order quantity: 100 pieces. Please contact your local distributor or VICI directly.

NOTES

- Stated porosities are only nominal and do not reflect the maximum pore size of a frit.
- See frit volume chart for help choosing the right frit and porosity for your application 109
- Frit volumes are theoretical and are calculated by multiplying overall frit volume times the porosity proportion.

SEE ALSO

Unidense type frits
 Polyethylene 86
 Stainless 87
 Titanium 87



SPECIFICATIONS

MATERIAL

Frit Titanium

Ring PEEK

TOLERANCES

±0.05 mm (.002")



Titanium frits

PEEK-ENCASED

- For HPLC columns or in-line filters
- Biocompatible – recommended for protein analysis
- Eliminate poorly swept volume and improves peak symmetry
- Higher corrosion resistance
- Various porosity and dimension options

In terms of biocompatibility, the frit is the critical spot for contributing metal ions to the mobile phase and for interaction with protein samples.

VICI Jour PEEK-encased frits with 1/5" or 1/4" OD ring are intended for HPLC columns with IDs of 3.2 and 4.6 mm. With the frit surrounded by a PEEK ring, the actual porous surface is reduced to the column ID.

The compressed PEEK ring forms a seal between the bottom of the fitting and the column end, preventing the mobile phase and the sample from entering the previously accessible poorly swept areas.

Sold in packages of 5.

Ring OD		Frit OD		Thickness		Porosity	Frit volume	Product No.
inches	mm	inches	mm	inches	mm	µm	µL	
1/5	5.08	.102	2.60	.062	1.59	5	3.20	JR-1128-5P-5
.25	6.35	.125	3.20	.062	1.59	0.5	3.32	JR-1127-05P-5
						2	4.47	JR-1127-2P-5
		.181	4.60	.062	1.59	0.5	6.87	JR-1125-05P-5
						2	2.94	JR-1125-2P-5
						5	10.04	JR-1125-5P-5
						10	10.56	JR-1125-10P-5

SPECIFICATIONS

MATERIAL

Frit UHMWPE

Ring PEEK

TOLERANCES

±0.05 mm (.002")



Polyethylene frits

PEEK-ENCASED

- Biocompatible
- Metal free

Our polymer frits are made of UHMWPE (Ultra High Molecular Weight PolyEthylene). They are a competitively priced alternative to titanium and are completely metal free.

With the frit surrounded by a PEEK ring, the actual porous surface is reduced to the column ID. The compressed PEEK ring forms a seal between the bottom of the fitting and the column end, preventing the mobile phase and the sample from entering the previously accessible poorly swept areas.

Sold in packages of 5.

Ring OD		Frit OD		Thickness		Porosity	Frit volume	Product No.
inches	mm	inches	mm	inches	mm	µm	µL	
1/5	5.08	.098	2.50	.059"	1.50	10	2.94	JR-1150-10P-5
.25	6.35	.181	4.60	.059"	1.50	10	11.31	JR-1151-10P-5

➔ OPTIONS AND MORE INFORMATION

See facing page.

t TECH TIPS

- PEEK-encased titanium frits can also be used as spare parts frits for the PEEK in-line filter kit62
- PEEK-encased polyethylene frits can be used as spare parts for: PEEK in-line filter kit62 PEEK columns91

COLUMNS



PEEK COLUMNS • GUARD COLUMNS

COLUMNS INDEX

PEEK COLUMNS

2.1 mm ID	page 91
4.0 mm ID	91

In-line biocompatible

guard columns	92
---------------------	----

This PEEK guard column system extends the life of valuable analytical columns by trapping contaminants from the sample and mobile phase. Only PEEK and titanium contact the mobile phase and sample.

COLUMN COUPLERS AND PLUGS

Column coupler, one-piece fingertight	93
Column end plugs	93
Column end plugs, logotype	93

Packing kits	92
--------------------	----

VICI Jour column packing kits are ready-to-use tools to pack our PEEK columns and PEEK guard columns. Includes needed slurry reservoir, packing adapter, and packing seals.



PEEK columns

2.1 mm ID

SPECIFICATIONS

MATERIAL
PEEK, black and natural

TOLERANCES
±0.05 mm (.002")

PRESSURE RATING (MAXIMUM)
210 bar (3000 psi)

During packing, using a VICI Jour packing kit:
350 bar (5000 psi)

- Biocompatible
- High pressure applications
- Packing devices available

We have designed this column for narrow-bore applications, and for those when a limit amount of sample is available for analysis.

Because 2.1 mm ID columns operate at 1/5th of the flow rate of their 4.6 mm counterparts, the same sample mass injected on a 2.1 mm column will increase the detector signal response by a factor of 5. This greater mass sensitivity provides the same analysis as on a 4.6 mm column with only 20% of the sample.

All our columns are delivered without frits. Purchase frits separately.

	Length	Qty/pkg	Product No.
2.1 mm ID PEEK columns	30 mm	1	JR-65001NF
	50 mm	1	JR-65002NF
	100 mm	1	JR-65003NF
	150 mm	1	JR-65005NF
	250 mm	1	JR-65006NF
Spare parts			
Column end fitting		1	JR-062-C
PEEK-encased frit	Titanium, 5 µm	5	JR-1128-5P-5
	Polyethylene, 10 µm	5	JR-1150-10P-5



PEEK columns

4.0 mm ID

SPECIFICATIONS

MATERIAL
PEEK, black and natural

TOLERANCES
±0.05 mm (.002")

PRESSURE RATING (MAXIMUM)
350 bar (5000 psi)

During packing, using a VICI Jour packing kit:
350 bar (5000 psi)

- Biocompatible
- High pressure applications
- Packing devices available

Today's HPLC and IC applications are more demanding than ever. The limitations of traditional stainless steel cause significant problems for a growing number of important biotechnology and ion chromatography applications.

All our columns are delivered without frits. Purchase frits separately.

	Length	Qty/pkg	Product No.
4.0 mm ID PEEK columns	50 mm	1	JR-68181NF
	100 mm	1	JR-68182NF
	125 mm	1	JR-68183NF
	150 mm	1	JR-68184NF
	250 mm	1	JR-68185NF
	300 mm	1	JR-68186NF
Spare parts			
Column end fitting		1	JR-66140
PEEK-encased frit	Titanium, 5 µm	5	JR-1125-5P-5
	Polyethylene, 10 µm	5	JR-1151-10P-5

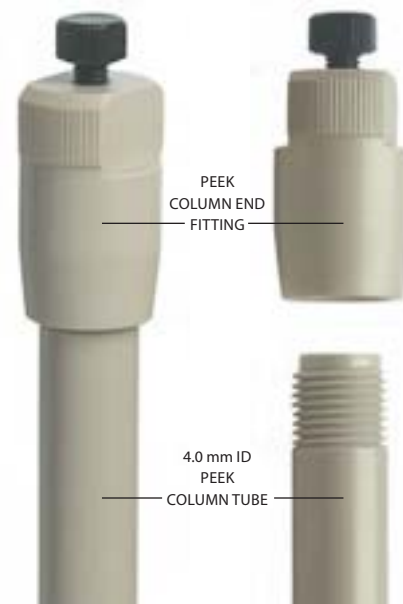

SEE ALSO

- Column packing kit... 92
- PEEK-encased frits
 - Titanium 89
 - Polyethylene frits 89



COLUMNS

In-line biocompatible guard column

- Biocompatible
- Easy to fill
- Packing device for do-it-yourself packing available

The VICI Jour in-line PEEK guard column system extends the life of valuable analytical columns by trapping contaminants from the sample and mobile phase, thereby preventing loss of retention.

Only PEEK and titanium contact the mobile phase and sample. This system is ideal for use with proteins or other biopolymers that may be contaminated or absorbed by steel surfaces. VICI Jour guard columns can be easily dry packed or slurry packed. Guard columns may be changed in minutes without the use of tools – all connections may be made by hand.

Guard column system includes:

- Guard column cartridge
- 2 Titanium frits
- Housing
- O-ring



Guard column cartridge includes:

- Guard column cartridge
- 2 Titanium frits (2 µm or 5 µm)

SPECIFICATIONS

MATERIAL
PEEK, titanium
PRESSURE RATING
< 350 bar (< 5000 psi)



		Qty/pkg	Product No.
Guard column system	2 µm	1	JR-68252TI2
	5 µm	1	JR-68252TI
Guard cartridge with 2 frits	2 µm	1	JR-68242TI2
	5 µm	1	JR-68242TI
Spare parts			
Replacement CTFE packing seal		1	JR-9

Packing kits

VICI Jour column packing kits are ready-to-use tools to pack our PEEK columns and PEEK guard columns. Every kit consists of the needed slurry reservoir, packing adapter, and packing seals.

	Product No.
For 2.1 mm ID columns	
Packing kit	JR-67-250-2A
Replacement PEEK packing adapter	JR-67140-1B
Replacement PEEK packing seal	JR-65011
For 4.0 mm ID columns	
Packing kit	JR-67-250-4
Replacement PEEK packing adapter	JR-67140-2B
Replacement PEEK packing seal	JR-66158
For in-line biocompatible guard columns	
Packing kit	JR-27305
Replacement CTFE packing seal	JR-9

SPECIFICATIONS

MATERIAL
PEEK
PRESSURE RATINGS
During packing, using a VICI Jour packing kit:

Column ID	Packing pressure
2.1 mm	350 bar (5000 psi)
4.0 mm	560 bar (8000 psi)

See column pages for operating pressure ratings.

t TECH TIP

Our packing kit is a "ready-to-use" tool to pack our PEEK guard cartridges. Every kit consists of the needed slurry reservoir, packing adapter, and packing seals.

t TECH TIP

This item requires a mechanical press to force the frits into position.

➔ SEE ALSO

- PEEK columns
- 2.1 mm ID 91
- 4.0 mm ID 91



One-piece fingertight column couplers

SPECIFICATIONS

MATERIAL
 Tubing PEEK
 Fittings PEEK
 Sleeve PP
 (Polypropylene)
THREADS
 10-32 male to 10-32 male
PRESSURE RATING
 <350 bar (5000 psi)

- Self-adjusting – zero dead volume for all fitting types
- Four bore sizes
- Biocompatible

Choose from a variety of coupler IDs, indicated by the color of the sleeve. A unique feature of this column coupler is that it adapts automatically to fit all pilot lengths – Valco, Waters, Upchurch, Rheodyne, etc. Since the tubing bottoms out in any fitting detail, added void volume is minimal.



Sold individually.

Color	ID	Product No.
Red	0.13 mm	JR-26501
Yellow	0.17 mm	JR-26502
Blue	0.25 mm	JR-26503
Orange	0.50 mm	JR-26504



Coupler shown installed between two columns
 (columns not included)

Column end plugs – logotype

SPECIFICATIONS

MATERIAL
 Nylon
THREADS
 10-32
TOLERANCES
 ±0.05 mm (.002")

- Customizable with your logo and color (OEM version)
- Same features as column end plugs below

Ensure safe closure of valuable columns with your own customized column end plugs. Easy handling is guaranteed by the 5/16" wrench flat. Fit all columns with 10-32 thread.

Sold in packages of 10.

Color	Product No.
White	JR-4081-10
Black	JR-4082-10
Red	JR-4083-10
Green	JR-4084-10
Blue	JR-4085-10



Column end plugs

SPECIFICATIONS

THREADS / MATERIAL
 10-32 Nylon
 6-40 POM
TOLERANCES
 ±0.05 mm (.002")

- Seal analytical columns
- Fingertight (with wrench flats on 10-32 versions)

Fingertight column end plugs fit all columns with 10-32 threads. Easy handling is guaranteed by an additional 5/16" wrench flat, which allows the plug to be loosened by a wrench if it gets stuck. The long design and threading down to the ferrule ensure safe closing of valuable columns.

Sold in packages of 10.

For small columns with 6-40 threads, fingertight (no wrench flat) plugs are available.

Sold individually.

Threads	Qty/pkg	Color	Product No.
10-32	10	White	JR-4071-10
		Black	JR-4072-10
		Red	JR-4073-10
		Green	JR-4074-10
		Blue	JR-4075-10
6-40	1	Natural POM	JR-4061



SEE ALSO

Color-coded PEEK tubing 10-12

SAMPLE LOOPS



VALCO • CHEMINERT® • RHEODYNE™

Sample loops are accurately sized for each valve type. However, with small volume loops, the tolerance on the ID of the tubing (± 0.001 ") can have a significant effect on the volume. Therefore loop volume and loop appearance may differ from batch to batch.

SAMPLE LOOPS INDEX

PEEK LOOPS

PEEK loops for:

Cheminert.....	page 95
Rheodyne.....	95
Valco.....	95

STAINLESS STEEL LOOPS

Stainless loops for:

Cheminert.....	96
Rheodyne.....	97
Valco.....	96

PEEK LOOPS

- Wide range of volumes available
- Biocompatible

VICI Jour PEEK sample loops are made from striped color-coded PEEK tubing and PEEK fittings. PEEK is a mechanically strong, chemically inert polymer ideal for HPLC applications. Since our PEEK sample loops contain no metals or other extractable compounds, no foreign materials will be introduced into the system. Softener-free polyethylene caps are used to avoid contamination of the tubing.

PEEK sample loops are particularly well suited for separations involving proteins, peptides, nucleic acids or other samples of biological origin as well as in IC systems where metal traces may interact with ionic samples or release transition metals that may deactivate ion exchange columns.

PEEK hex-head nuts and PEEK ferrules provide reliable connections, and avoid twisting of the tube.

! DISCLAIMER

The maximum holding pressure for any type of connections involving tubing and a ferrule varies considerably with the tubing material the ferrule material, the clearance between tubing OD and ferrule ID, and the shape of the fitting detail.

t TECH TIP

The tighter ID tolerance of the tubing minimizes the tolerance of the loop volume.

➔ SEE ALSO

ValvTool..... 102



SPECIFICATIONS

MATERIAL

- Loops PEEK
- Nuts PEEK
- Ferrules PEEK
- Caps PE (Polyethylene)

TOLERANCES

±0.025 mm (.001")

* Recommended maximum permanent working pressure

PEEK loops

FOR CHEMINERT VALVES

Fit all Cheminert injection valves for 1/16" OD tubing (for example, C2).

Sample size	Pressure *		Product No.
	bar	psi	
NEW 1 µl	400	5800	JR-SLC-85-1
NEW 2 µl	400	5800	JR-SLC-85-2
NEW 3 µl	400	5800	JR-SLC-85-3
NEW 4 µl	400	5800	JR-SLC-85-4
5 µl	400	5800	JR-SLC-85-5
10 µl	400	5800	JR-SLC-85-10
20 µl	400	5800	JR-SLC-85-20
50 µl	400	5800	JR-SLC-85-50
100 µl	400	5800	JR-SLC-85-100
200 µl	240	3500	JR-SLC-85-200
250 µl	240	3500	JR-SLC-85-250

Sample size	Pressure *		Product No.
	bar	psi	
300 µl	240	3500	JR-SLC-85-300
500 µl	240	3500	JR-SLC-85-500
1 ml	240	3500	JR-SLC-85-1000



PEEK loops

FOR RHEODYNE VALVES

Fit all Rheodyne metal and metal-free valves.



Sample size	Pressure *		Product No.
	bar	psi	
NEW 1 µl	435	6300	JR-SLR-2190
NEW 2 µl	420	6100	JR-SLR-2191
NEW 3 µl	420	6100	JR-SLR-2192
NEW 4 µl	420	6100	JR-SLR-2193
5 µl	400	5800	JR-SLR-2194
10 µl	400	5800	JR-SLR-2196
20 µl	386	5600	JR-SLR-2195
30 µl	386	5600	JR-SLR-2200

Sample size	Pressure *		Product No.
	bar	psi	
40 µl	386	5600	JR-SLR-2201
50 µl	350	4500	JR-SLR-2202
100 µl	350	4500	JR-SLR-2204
200 µl	240	3500	JR-SLR-2206
250 µl	240	3500	JR-SLR-2207
500 µl	240	3500	JR-SLR-2210
1 ml	240	3500	JR-SLR-2222

PEEK loops

FOR VALCO VALVES

Fit all 1/16" Valco W and UW type valves.

Sample size	Pressure *		Product No.
	bar	psi	
NEW 1 µl	400	5800	JR-SLV-75-1
NEW 2 µl	400	5800	JR-SLV-75-2
NEW 3 µl	400	5800	JR-SLV-75-3
NEW 4 µl	400	5800	JR-SLV-75-4
5 µl	400	5800	JR-SLV-75-5
10 µl	400	5800	JR-SLV-75-10
20 µl	400	5800	JR-SLV-75-20
50 µl	400	5800	JR-SLV-75-50
100 µl	400	5800	JR-SLV-75-100

Sample size	Pressure *		Product No.
	bar	psi	
250 µl	240	3500	JR-SLV-75-250
500 µl	240	3500	JR-SLV-75-500
1 ml	240	3500	JR-SLV-75-1000



TECH TIPS

- See general information about PEEK loops on facing page.
- The ValvTool tightens nuts with tube or loop installed, providing easy access to many hard-to-reach areas. 102



OPTIONS

Other sample sizes are available on request. Please contact your distributor or VICI Jour directly.

SEE ALSO

Chemical resistance . . . 110
About PEEK 113

Spare parts

FOR PEEK CHEMINERT, RHEODYNE, AND VALCO LOOPS

Sold in packages of 5.

		Product No.
PEEK nuts	for use with double ferrules, 1/16" hex head long, 10-32	JR-5510-5
PEEK ferrules	single ferrules, 1/16" (Use 2 per nut, as shown)	JR-5005-5





STAINLESS STEEL LOOPS

- Wide range of volumes available
- Ultra high pressure resistance

VICI Jour stainless steel sample loops are made of high quality SS316. They are cut using an electrolytic cutting process, cleaned with ultrasound and high pressure steam to remove contaminants, dried, and capped with softener-free caps to avoid recontamination of the tubing.

All loops are supplied with stainless hex-head nuts and stainless ferrules for reliable connections.

SPECIFICATIONS

MATERIAL

Loops	SS316
Nuts	SS303
Ferrules	SS316
Caps	PE (Polyethylene)

TOLERANCES

±0.05 mm (.002")

PRESSURE RATING

≤ 1375 bar (≤ 20,000 psi)

Stainless steel loops

FOR CHEMINERT VALVES

Fit all Cheminert C1, C1CF, C2, C2V, C3, C52, C72H, and C72X type valves.

Sample size Product No.

NEW 1 µl	JR-SLC-86-1
NEW 2 µl	JR-SLC-86-2
NEW 3 µl	JR-SLC-86-3
NEW 4 µl	JR-SLC-86-4
5 µl	JR-SLC-86-5
10 µl	JR-SLC-86-10
20 µl	JR-SLC-86-20
50 µl	JR-SLC-86-50
100 µl	JR-SLC-86-100
250 µl	JR-SLC-86-250
500 µl	JR-SLC-86-500
1 ml	JR-SLC-86-1000



Stainless steel loops

FOR VALCO VALVES

Fit all 1/16" Valco W and UW type valves.

Sample size Product No.

5 µl	JR-SLV-76-5
10 µl	JR-SLV-76-10
20 µl	JR-SLV-76-20
50 µl	JR-SLV-76-50
100 µl	JR-SLV-76-100
250 µl	JR-SLV-76-250
500 µl	JR-SLV-76-500
1 ml	JR-SLV-76-1000



Spare parts FOR STAINLESS CHEMINERT AND VALCO LOOPS

Sold in packages of 5.

	Product No.
1/16" stainless nuts, 10-32	JR-ZN1-5
1/16" stainless ferrules	JR-ZR1S6-5



Stainless steel loops

FOR RHEODYNE VALVES

- Fit all Rheodyne valves
- Special loops for valve Model 7725

Sample size	Product No.
5 µl	JR-SLR-111
10 µl	JR-SLR-112
20 µl	JR-SLR-113
50 µl	JR-SLR-114
100 µl	JR-SLR-115
200 µl	JR-SLR-116
500 µl	JR-SLR-117
1 ml	JR-SLR-118
Loops for Rheodyne valve 7725, 1/16"	
3 µl	JR-SLR-110-77
5 µl	JR-SLR-111-77
10 µl	JR-SLR-112-77
20 µl	JR-SLR-113-77
50 µl	JR-SLR-114-77
100 µl	JR-SLR-115-77
200 µl	JR-SLR-116-77
500 µl	JR-SLR-117-77
1 ml	JR-SLR-118-77



TECH TIPS

- Not recommended for use with halides.
- We offer nuts in three lengths to facilitate wrench access on valves. For loops that will be replaced frequently, we recommend our longest nut – particularly when space is restricted. See long nuts.37
- The ValvTool tightens nuts with tube or loop installed, providing easy access to many hard-to-reach areas. 102



OPTIONS

Other sample sizes are available on request. Please contact your distributor or VICI Jour directly.

SEE ALSO

About stainless steel. . 114

Spare parts

FOR STAINLESS RHEODYNE LOOPS

Sold in packages of 5.

		Product No.
1/16" Rheodyne type stainless nuts	For valve 7725, long head	JR-57-5
	X-long	JR-58-5
Stainless ferrules	1/16"	JR-59-5
	2-step Rheodyne type, 1/16"	JR-60-5

ACCESSORIES

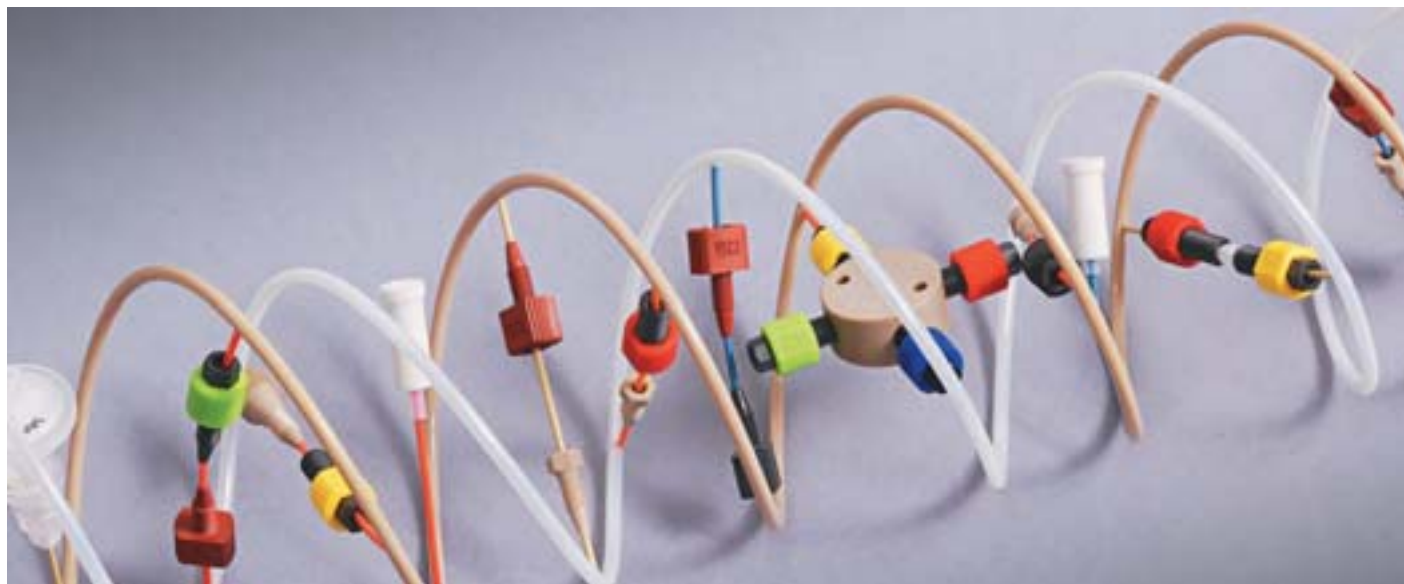

TOOLS • STARTER KITS • BACK-PRESSURE REGULATOR

Our low pressure fittings are ideally suited for flow injection analysis, low pressure liquid chromatography, and stream sampling devices. They may be safely used at pressures up to 500 psi and temperatures to 50°C.

ACCESSORIES INDEX

ACCESSORIES FOR TUBING

Easy-Flange kit	page 99
Easy-Flange combi kit	99
PEEK tubing elbows	100
Tubing clip	100
Tubing cutters	100-101

ACCESSORIES FOR FITTINGS

Color-It fingertight adapters	23
Work great with all our PEEK and stainless hex head nuts for 1/16" tubing.	
Color-Sleeve adapters	23
Designed to be used with our black PPS nuts and one-piece fittings.	

BACK-PRESSURE REGULATORS 102

Our back-pressure regulators improve baseline stability by preventing bubble formation in the flow cell.

TOOLS

Ferrule removal kit	103
File	101
Hex key set	103
Tweezer	103
Wrench	103
ValvTool	102
Tubing cutters	
For polymeric	100
For stainless	101

STARTER KITS

Easy flange combi kit	99
Flange-rolling tool, PTFE tubing, fittings, and accessories	
PEEK starter kit	104
PEEK fittings and tubing	
Stainless starter kit	104
Stainless steel fittings and tubing	
ChromBox kit	105
PEEK and stainless fittings and tubing	

MORE INFO

Color-Sleeve adapters turn PPS nuts into fingertight fittings and color-code different solvent lines. 23



Color-It fingertight adapters work great with all our PEEK and stainless hex head nuts for 1/16" tubing. 23





Easy-Flange kit

- Handy tool for perfect flanges
- No heat or electricity required
- No contamination

The Easy-Flange flange-rolling tool for flanged fittings is suitable for PTFE and PTFE-like tubes with OD between 1/16" and 1/8". The tool forms the flange by applying a mechanical force and does not require electrical power.

The quality of the flange is considerably improved over other available methods, since the tubing is not stressed by heat and because the specially-designed negative conical profile of the flange-forming part yields an ideal shape for optimized sealing properties.

Product No.

Easy-Flange kit	JR-201540
-----------------	-----------

Kit includes:

	Qty	Product No.
Easy Flange Handle, complete	1	JR-201540B
Flanging discs with:	0.5 mm SS pin for PEEK tubing	1 JR-202235
	0.8 mm polymer pin	1 JR-201541
	0.8 mm titanium pin	1 JR-201554
	1.3 mm polymer pin	1 JR-201536
	1.3 mm titanium pin	1 JR-201537
Clean-Cut tubing cutter	1	JR-797
Tubing, PTFE, 1/16" x 0.75 mm ID	2 m	JR-T-4036
Plastic box	1	JR-201540L
Flanger/distance gauge	1	JR-201532



Easy-Flange combi kit

In addition to the contents of the Easy-Flange kit, the combi kit includes 1/8" PTFE tubing, nuts/rings for tube end fittings, and color-coded adapters.

Product No.

Easy-Flange combi Kit	JR-201539
-----------------------	-----------

Kit includes:

	Qty	Product No.
Easy-Flange kit above	1	JR-201540
PP nuts, 1/4-28, flanged	White, for 1/16" tubing	1 pkg JR-201094WH-10
	Black, for 1/8" tubing	1 pkg JR-201580BK-10
PP washers	For 1/16" tubing	10 JR-201926-10
	For 1/8" tubing	10 JR-201928-10
PTFE tubing	1/16" x 0.75 mm ID	3m JR-T-4036-M3
	1/8" x 1/16" ID	3m JR-T-6800-M3

OPTIONS

Additional sizes of flanging discs are available.

Flanging disc with:

Polymer pin	Product No.
1.0 mm	JR-201662
1.5 mm	JR-201663

SEE ALSO

Flanged fittings. . . . 44, 49
Polymeric tubing 9-17

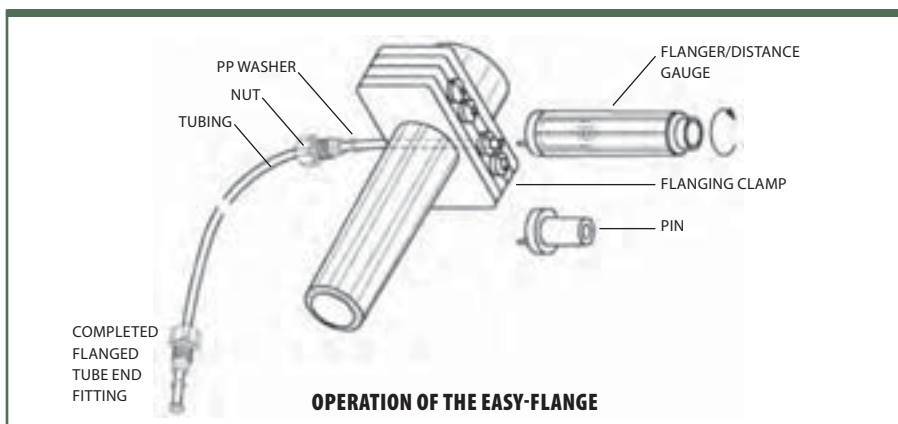

Tubing accessories and tools



ACCESSORIES

PEEK tubing elbows

Tubing elbows (90° and 180°) are ideal for routing 1/16" PEEK tubing through an LC system. These elbows are proportioned to bend PEEK tubing at the optimum radius for maximum chemical resistance and burst pressure. Installation is simple – just snap the tubing into the elbow.

Sold individually.

Product No.	
90° elbow	JR-357090
180° elbow	JR-357180

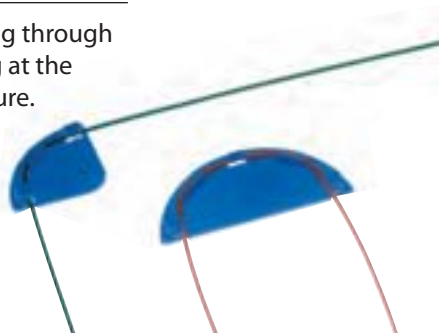

Tubing clip

THE LC TUBING ORGANIZER

- Fixes 1/16" and 1/8" tubing to beakers, flasks, or bottles
- Stainless steel spring for long life

This convenient device holds both 1/16" and 1/8" polymer tubes precisely where they should be in your beakers, flasks and bottles etc. up to 4 mm wall thickness. The stainless steel spring will keep your tubing clip working for a long time, and helps keep the solvent line in the solvent.

Product No.	
Tubing clip	JR-9001



Clean-Cut tubing cutter

FOR POLYMERIC TUBING

- Cuts PEEK, PTFE, ETFE, and other polymeric tubing
- No distortion to OD or ID
- Ideal for the most demanding LC applications
- For 1/16", 2mm, 3mm, 1/8" and 4mm tubing OD
- Safety lock secures the blade

Right angles and clean cuts are essential in LC to avoid leaks and dead volume. This handy tool makes it easy to get burr-free, perpendicular ends on polymeric tubing without distorting the outside diameter and/or closing the inside diameter of the tubing.

It is designed to cut PTFE, ETFE and polymers in general and PEEK capillary tubing in particular. The compact design and unique safety locking mechanism allow every chromatographer to keep one in their pocket.

Product No.	
Clean-Cut tubing cutter	JR-797
Replacement blade	JR-798

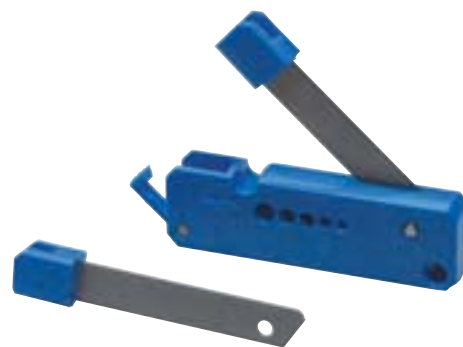

Guillotine tubing cutter

FOR POLYMERIC TUBING

- Cuts PEEK, PTFE, ETFE, and other polymeric tubing
- Ideal for less demanding LC applications

Product No.	
Guillotine tubing cutter	JR-794
Replacement blade	JR-795

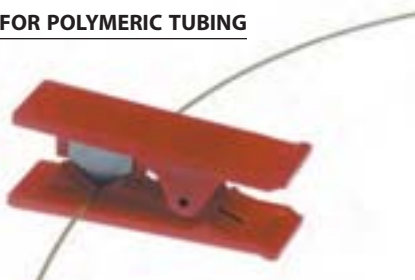



Stainless steel tubing cutter

CUTTING WHEEL TYPE

- For 1/16" and 1/8" SS tubing
- Leaves smooth, uniform cuts
- Minimal deburring and/or reaming required
- Easy replacement of the cutting wheel

This is the ideal tool for cutting 1/16" and 1/8" stainless steel tubing, leaving smooth, uniform cuts requiring a minimum of deburring and/or reaming. The easily replaced cutting wheel scores tubing, leaving cuts which allow tube-to-tube and tube-to-frit connections.

<i>Product No.</i>	
Tubing cutter for metal tubing	JR-792
Replacement cutting wheel	JR-793



Stainless steel tubing cutter

PLIER TYPE

- For easy cutting of 1/16" tubing off a coil
- Reach "hard-to-get" places in an HPLC system
- Delivered in a plastic sheath

These pliers can be used for quick cuts for non-critical applications or at "hard to get" places. However, for scientific equipment, we strongly recommend our pre-cut and cleaned stainless tubing.

<i>Product No.</i>	
Tubing pliers for metal tubing	JR-796



File

This deburring file is handy tool for cleaning up metal tubing ends.

<i>Product No.</i>	
Deburring file	JR-802

t TECH TIP

Between the sample injector, column, and detector, use our pre-cut stainless steel tubing, which has been electrolytically cut and steam cleaned. 20

➔ SEE ALSO

Pre-cut stainless steel tubing. 20



HPLC Backpressure regulators

- Improve baseline stability by preventing bubble formation in the flow cell
- Adjust backpressure without disconnecting anything
- Easy mount with 17 mm panel hole
- Three models, all with low dead volume
- Two models with completely biocompatible fluid path
- One model in stainless steel for preparative chromatography and SFC

Even properly degassed mobile phases may contain some dissolved gases that can release bubbles in the detector flow cell resulting in baseline noise and drift. VICI Jour backpressure regulators provide a quick and convenient way to improve the stability of detector baseline by providing a constant back-pressure on the flow cell, which stops the release of dissolved gases from the mobile phase.

Because of their unique design, the backpressure regulators have a very small internal volume. The peak shape is not affected when the regulator is installed between two detectors in a multi-detector system, or between a detector and a fraction collector or fraction collector system. Typically, 90% or more of a given component's efficiency will be retained upon passing through the regulator.

A spring-loaded diaphragm provides the force that generates the back-pressure. Spring tension may be adjusted using the backpressure adjustment screw on the top of the regulator to vary the backpressure without disconnecting any lines.

Backpressure regulators are available in three ranges as noted below.

	Range		Housing	Product No.
	1-20 bar	15-300 psi		
Biocompatible			PEEK	JR-BPR1
			PCTFE	JR-BPR-1KF
	20-103 bar	300-1500 psi	PEEK	JR-BPR2
			PCTFE	JR-BPR-2KF
Stainless steel	90-300 bar	1300-4200 psi	SS	JR-BPR3

SPECIFICATIONS

TUBING OD / THREADS
1/16" 10-32

MATERIAL

Wetted parts:

JR-BPR-1 and JR-BPR-2

Housing PEEK/PCTFE

Membrane Polyimide

JR-BPR-3

Housing SS

Membrane Polyimide

DEAD VOLUME

0.25 µl (theoretical)



ValvTool

- For making connections in hard-to-reach areas
- Ideal for nuts with 1/4" hex and 5/16" heads

The ValvTool is a time-saving device which provides easy access to many hard-to-reach areas. The unique design with its slotted wrench allows tightening of nuts where a loop or a capillary might otherwise make it difficult. The ValvTool is ideal for Valco and Rheodyne® valves and fittings, as well as most of the HPLC and PEEK fittings on the market with 1/4" and 5/16" heads.

	Product No.
ValvTool wrench, 1/4" and 5/16"	JR-800

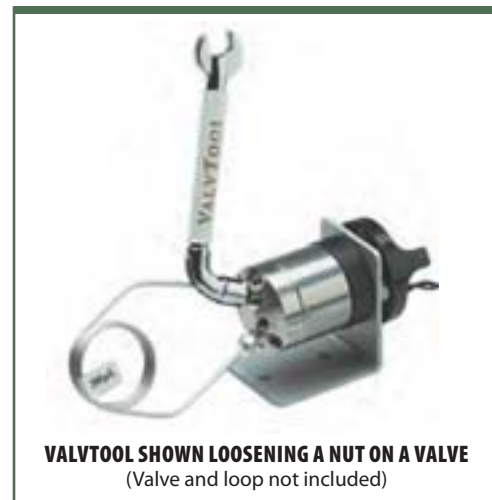

VALVTOOL SHOWN LOOSENING A NUT ON A VALVE
(Valve and loop not included)



FERRULE REMOVAL KIT
For 360 µm and 1/32" ferrules



FERRULE REMOVAL KIT
For 1/16" and 1/8" ferrules

Ferrule removal kits

- Remove polymeric ferrules stuck in fitting details
- One version for 1/32" and 360 micron ferrules
- Another version for 1/16" and 1/8" ferrules

Ferrule removal kits are easy-to-handle tools for removing ferrules stuck in a fitting detail. Two versions cover four different ID's of ferrules.

	For use with	Product No.
Ferrule removal kits	360 µm and 1/32" ferrules	JR-FRK1
	1/16" and 1/8" ferrules	JR-FRK2

Hex key set



The hex key set has a wrench to fit any socket head screw on any VICI valve or actuator. Includes the following sizes: .050", 1/16", 5/64", 3/32", 7/64", 1/8", 9/64", and 5/32".

	Product No.
Hex ket set	JR-HKS3



Tightening tools for PEEK fittings

These handy tools make it fast and easy to tighten hex-head fittings. The green tool is for any 1/32" fitting with a 3/16" hex head nut, and the blue version fits the 1/4" hex common in fittings for 1/16" tubing.

Color	For use with	Product No.	
Green	1/32" fittings	JR-CNFT	
Blue	1/16" fittings	JR-ZNFT	



Tweezer

Ideal for picking up small fittings, etc.

	Product No.
Tweezer	JR-806

Wrenches

Open end wrenches for nuts with 1/4", 5/16", 3/8", or 7/16" heads.

		Product No.
Open end wrench	1/4" and 5/16"	JR-804
	3/8" and 7/16"	JR-805



Socket wrenches

Hex-head socket wrench for nuts with 1/4" head.

	Product No.
Hex-head socket wrench	JR-SWH4



SEE ALSO

Deburring file 101
Tools for tubing . 100-101

Starter kits • PEEK and stainless steel



ACCESSORIES

PEEK starter kit

- All parts biocompatible
- Ideal kit for all HPLC users

The PEEK starter kit is ideal for anyone working in the field of biochromatography. It consists of fittings, ferrules, tubing, and mobile phase filters, as well as a union, our Clean-Cut tubing cutter, and other useful accessories like our tubing elbows – all boxed together for a very competitive price.

For a number of interesting LC applications involving proteins, peptides, nucleic acids, or other samples of biological origin, metal systems may interact with samples or release transition metals that will deactivate columns. Replacing stainless steel parts (such as tubing fittings, ferrules, filters, etc.) with PEEK creates a biocompatible environment for samples and mobile phase.

Description		Product No.	
PEEK starter kit		JR-35P	
<i>Kit includes:</i>		<i>Qty</i>	<i>Product No.</i>
PEEK fittings	One-piece 10-32 fittings	10	JR-55020-1
	Fingertight 10-32 nuts	5	JR-5580
	Hex-head long 10-32 nuts	5	JR-5510
	1/16" double ferrules	20	JR-5004
	Union body, 0.25 mm bore	1	JR-061
PEEK tubing, 1/16" OD	0.25 mm ID x 3 m, blue stripe	1	JR-T-6001-M3
	0.50 mm ID x 3 m, orange stripe	1	JR-T-6002-M3
Filters	PEEK in-line filter kit	1	JR-68256
	Last Drop mobile phase filter, 5 µm, PTFE	1	JR-9000-0521
Accessories	Tubing elbow, 90°	2	JR-357090
	Tubing elbow, 180°	2	JR-357180
Tools	Clean-Cut polymeric tubing cutter	1	JR-797
	Tweezer	1	JR-806



Stainless steel starter kit

UHPLC

The kit consists of stainless fittings, ferrules, tubing, and solvent filters, as well as a union, our cutting-wheel type metal tubing cutter, and other useful items like our ValvTool. All boxed together for a very competitive price.

Description		Product No.	
Stainless steel starter kit		JR-35S	
<i>Kit includes:</i>		<i>Qty</i>	<i>Product No.</i>
Stainless fittings	1/16" nuts, 10-32	10	JR-ZN1
	1/16" nuts, 10-32, 19 mm long	10	JR-LZN1
	1/16" ferrules	20	JR-ZF1S6
	1/16" union with nuts/ferrules, 0.25 mm bore	1	JR-ZU1CS6
Stainless tubing	1/16" x 0.25 mm x 3 m	1	JR-T-625-10-M3
	1/16" x 0.50 mm ID x 3 m	1	JR-T-625-20-M3
	1/16" x 0.18 mm ID x 100 mm	2	JR-T-97030
	1/16" x 0.25 mm ID x 200 mm	2	JR-T-97060
Filters	Mobile phase, 2 µm, 1/8" pipe OD	1	JR-3675-2
	Stainless in-line, 0.25 mm ID	1	JR-68230-5
	Last Drop, 10 µm	1	JR-9000-0532
Tools	ValvTool 1/4" x 5/16" wrench	1	JR-800
	Open end wrench, 1/4" x 5/16"	1	JR-804
	Tubing cutter	1	JR-792
	Tweezer	1	JR-806



➔ MORE INFO

IN THE PEEK KIT

PEEK fittings	
One-piece 10-32 fittings	26
Nuts for double ferrule	
Fingertight	29
Hex-head, long	29
Double ferrules	29
Union body	32
PEEK tubing	
Color-coded striped	10
Filters	
PEEK in-line filter kit	62
Last Drop mobile phase filter	57
Accessories	
Tubing elbows	100
Tools	
Clean-Cut polymeric tubing cutter	100
Tweezer	103

IN THE STAINLESS KIT

Stainless fittings	
1/16" nuts	37
1/16" ferrules	38
1/16" union	40
Stainless tubing	19-20
Filters	
Mobile phase	61
Stainless in-line	65
Last Drop	57
Tools	
ValvTool	102
Open end wrench	103
Tubing cutter	101
Tweezer	103



ChromBox kit

Includes

- PEEK, PTFE, and stainless tubing
- PEEK and stainless nuts, ferrules, and unions
- Tubing cutters and wrenches
- More accessories, all in a convenient carrying case

The ChromBox is an all-purpose analytical spare parts kit for all our customers using HPLC. It contains the most often used spare parts made both of high quality Type 316L stainless steel as well as PEEK and PTFE.



UTILITY BOXES

Additional empty utility boxes are available to store all the chromatographic accessories in your lab, providing convenient storage near the chromatographic system.

Prod No.

Utility box	JR-35U
-------------	--------



MORE INFO

IN THE CHROMBOX KIT

PEEK fittings	
One-piece 10-32 fittings	26
Nuts for double ferrule	
Fingertight	29
Hex-head, long	29
Double ferrules	29
Union body	32
Stainless fittings	
1/16" nuts	37
1/16" ferrules	38
1/16" union	40
Tubing	
Color-coded	
striped PEEK	10
PTFE	15
Stainless	19
Filters	
PEEK in-line filter kit	62
Stainless in-line	65
Accessories	
Tubing elbows	100
Tubing clip	100
Tools	
Clean-Cut polymeric tubing cutter	100
Plier style stainless tubing cutter	101
ValvTool	102
Open end wrench	103
Deburring file	101
Tweezer	103

Description		Product No.		
ChromBox kit		JR-34N		
<i>ChromBox kit includes:</i>				
		Qty	Product No.	
PEEK fittings	One-piece 10-32 fittings	5	JR-55020-1	
	Fingertight 10-32 nuts	5	JR-5580	
	Long hex-head 10-32 nuts	5	JR-5510	
	1/16" double ferrules	10	JR-5004	
	Union, 0.25 mm bore, body only	1	JR-061	
SS fittings	1/16" nuts, 10-32, 13 mm long	5	JR-MZN1	
	1/16" nuts, 10-32, 19 mm long	5	JR-LZN1	
	1/16" ferrules	10	JR-ZF1S6	
	1/16" union w/ nuts and ferrules, 0.50 mm bore	1	JR-ZU1MS6	
Tubing	PEEK	1/16" x 0.25 mm ID x 3 m, blue stripe	1	JR-T-6001-M3
		1/16" x 0.50 mm ID x 3 m, orange stripe	1	JR-T-6002-M3
	PTFE	1/8" x 1/16" ID x 3 m	1	JR-T-6800-M3
	Stainless	1/16" x 0.25 mm x 3 m	1	JR-T-625-10-M3
		1/16" x 0.50 mm ID x 3 m	1	JR-T-625-20-M3
Filters	PEEK in-line filter kit		1	JR-68256
	Stainless Last Drop, 2 µm		1	JR-9000-0530
Accessories	Tubing elbow, 90°		1	JR-357090
	Tubing elbow, 180°		1	JR-357180
	Tubing clip		2	JR-9001
Tools	Clean-Cut polymeric tubing cutter		1	JR-797
	Plier style SS tubing cutter		1	JR-796
	ValvTool 1/4" x 5/16" wrench		1	JR-800
	Open end wrench, 1/4" x 5/16"		1	JR-804
	Deburring file		1	JR-802
	Tweezer		1	JR-806

GENERAL REFERENCE



CHEMICAL RESISTANCE • MATERIALS • GLOSSARY

REFERENCE INDEX

TUBING CHARTS

Maximum working pressures
 Stainless steel tubing page 107
 PEEK tubing 108
 Polymeric tubing 108
 Tubing tolerances..... 109
 Tubing volume/length conversion. 107

VOLUME – FRITS 109

STANDARD THREADS 109

CHEMICAL RESISTANCE CHARTS

PEEK at high temperature 110
 PEEK and other polymers.....110-112

PROPERTIES OF MATERIALS

Metals 114
 Polymers112-113

MISCELLANEOUS

Glossary116-120
 Safety 115
 Trademarks 115

CONVERSION TABLES

Length 121
 Pressure 121
 Temperature..... 121

Index

By product numbers122-123
 Alphabetical by product name 124-125

ORDER INFORMATION 126

GENERAL CONVERSION FACTORS

inches to mm	inches x 25.4 = mm
feet to meters	feet x 0.3048 = meters
meters to feet	meter x 3.28 = feet

bar to psi	bar x 14.5 = psi
psi to bar	psi x 0.069 = bar
psi to kPa	psi x 6.9 = kPa

SEE ALSO

Tubing
 ETFE..... 13
 FEP..... 16
 PEEK 9-12
 Dual-layer 11
 Natural 9
 Solid-color..... 12
 Striped 10
 PFA..... 13
 PTFE
 Natural 15
 Solid-color..... 14
 Stainless steel
 Premium grade 19
 Welded..... 19



TUBING VOLUME/LENGTH CONVERSION CHART

1/16" OD tubing sold by VICI typically has an ID tolerance of ±0.025 mm. This is much tighter than normal commercial grades of tubing; however, it is enough to result in noticeable error if exact volumes are not measured, according to the equation

$$V = \Pi (\frac{1}{2} D)^2 L.$$

Tubing ID		Volume/length	
mm	inches	µl/cm	µl/in
0.050	.002"	0.02	0.05
0.064	.0025"	0.03	0.08
0.075	.003"	0.04	0.12
0.10	.004"	0.08	0.21
0.13	.005"	0.13	0.32
0.17	.0067"	0.23	0.58
0.18	.007"	0.25	0.63
0.25	.010"	0.51	1.29
0.38	.015"	1.14	2.90
0.50	.020"	2.03	5.15
0.64	.025"	3.17	8.04
0.75	.030"	4.56	11.58

Tubing ID		Volume/length	
mm	inches	µl/cm	µl/in
1.00	.040"	8.11	20.59
1.40	.055"	15.39	38.93
1.52	.060"	18.24	46.33
1.59	.062"	19.86	49.47
1.65	.065"	21.38	54.38
1.70	.067"	22.70	57.78
1.78	.070"	24.83	63.06
2.00	.079"	31.42	80.32
2.10	.083"	34.64	88.66
2.16	.085"	36.61	92.99
2.40	.094"	45.24	113.72
3.18	.125"	79.4	201
3.76	.148"	111	282
4.35	.171"	149	376

MAXIMUM RECOMMENDED WORKING PRESSURES FOR STAINLESS STEEL TUBING

i WORKING PRESSURE FOR STAINLESS STEEL TUBING

The working pressure for stainless tubing is calculated from the burst pressure by dividing by 2.5.

The theoretical burst pressure(s) were calculated using Lamé's formula and a safety factor of 2. Additionally, these results assume the tubing is not subject to any other stresses (e.g. temperature different from ambient, bends) that would influence the calculations. The end user must decide the safe maximum working pressure based on this information and the specific application.

Note: All pressure ratings are calculated for room temperature.

PREMIUM GRADE STAINLESS TUBING							
OD	ID (mm)	bar	psi	OD	ID (mm)	bar	psi
1/32"	0.13	1735	25,160	1/8"	0.68	1622	23,520
	0.18	1601	23,225		0.75	1572	22,800
	0.25	1395	20,230		1.00	1406	20,400
	0.50	734	10,645		1.50	1075	15,600
1/16"	0.13	1902	27,580		1.70	960	13,920
	0.18	1835	26,610		2.16	662	9,600
	0.25	1735	25,160	1/4"	4.65	554	8,040
	0.50	1395	20,230				
	0.75	1067	15,480				
	1.00	734	10,645				

WELDED STAINLESS TUBING			
OD	ID (mm)	bar	psi
1/16"	0.13	1871	27,140
	0.18	1794	26,025
	0.25	1717	24,910
	0.50	1384	20,080
	0.75	1076	15,610
1/8"	1.00	743	10,780
	2.10	680	9,860
1/4"	4.65	538	7,800



GENERAL REFERENCE

MAXIMUM RECOMMENDED WORKING PRESSURES – PEEK TUBING

PEEK TUBING															
OD	ID (µm)	bar	psi	OD	ID (mm)	bar	psi	OD	ID (mm)	bar	psi	OD	ID (mm)	bar	psi
360 µm	50	358	5200	1/32"	0.050	455	6600	1/16"	0.050	480	7000	1/8"	0.75	379	5500
	75	345	5000		0.064	455	6600		0.064	480	7000		1.59	248	3600
	100	300	4400		0.075	455	6600		0.075	470	6800		2.00	179	2600
	125	275	4000		0.100	455	6600		0.100	460	6700	1/4"	3.17	227	3300
	150	240	3500		0.13	414	6000		0.13	460	6700				
			0.15		400	5800	0.18		440	6400					
			0.18		386	5600	0.25		420	6100					
			0.20		369	5350	0.50		345	5000					
			0.25		338	4900	0.75		262	3800					
			0.38		269	3900	1.00		179	2600					
			0.50	207	3000	1.40	55	800							

MAXIMUM RECOMMENDED WORKING PRESSURES – POLYMERIC TUBING

FEP TUBING											
OD	ID (mm)	bar	psi	OD	ID (mm)	bar	psi	OD	ID (mm)	bar	psi
1/32"	0.13	78	1100	1/8"	1.59	69	1000	1.0 mm	0.50	62	900
	0.15	78	1100		2.10	41	600	2.0 mm	1.00	62	900
	0.18	72	1050		2.40	30	345	3.0 mm	1.00	82	1200
	0.25	68	980	3/16"	3.18	41	600		2.00	41	600
	0.38	51	750	1/4"	3.96	45	660	4.0 mm	3.00	28	420
	0.50	35	500		4.35	45	650				
1/16"	0.25	117	1700	3/16"	29	420					
	0.50	96	1400	5/16"	1/4"	22	330				
	0.75	76	1100								
	1.00	52	750								

ETFE TUBING			
OD	ID (mm)	bar	psi
1/32"	0.25	152	2200
1/16"	0.25	186	2700
	0.50	152	2200
	0.75	117	1700
	1.00	83	1200
1/8"	1.59	110	1600
	2.40	49	710
1/4"	4.80	48	710
3.0 mm	1.00	138	2000
6.0 mm	4.00	69	1000

PFA TUBING			
OD	ID (µm)	bar	psi
1/16"	0.50	100	1450
	0.75	76	1100
	1.00	55	800
1/8"	1.59	72	1050
	1.70	65	940
3/16"	3.20	41	600
1/4"	4.00	49	720
	4.35	45	650
	4.80	31	450

PTFE TUBING			
OD	ID (mm)	bar	psi
1/16"	0.18	62	900
	0.25	55	800
	0.50	48	700
	0.75	37	550
	1.00	25	350
1/8"	1.59	35	500
	2.40	18	250
1/4"	4.75	17	250
2.0 mm	1.70	10	150
4.0 mm	3.00	17	250
4.76 mm	3.76	14	200

WORKING PRESSURE FOR POLYMERIC TUBING

The quoted maximum working pressure(s) were calculated from the burst pressure and the factor 2.5. These results assume the tubing is at room temperature.



TOLERANCES – PEEK TUBING

Due to tighter tolerances, VICI Jour PEEK tubing is the best choice for chromatography applications in which exact flow rates or tube volume are of importance. The tighter tolerance ensures a more consistent internal volume of transfer lines.

PEEK TUBING		
Tubing OD	OD (±)	ID (±)
1/32"	0.025 mm	0.025 mm
1/16"	0.050 mm	0.025 mm
1/8"	0.075 mm	0.075 mm
1/4"	0.100 mm	0.100 mm

TOLERANCES – POLYMERIC TUBING

ETFE and PFA	
Tubing OD	OD and ID (±)
1/16" *	0.05 mm
1/8"	0.10 mm
1/4"	0.10 mm OD
	0.20 mm ID
* ETFE with 0.20 mm ID: OD ± 0.07 Wall ± 0.08	

FEP	
Tubing OD	OD and ID (±)
1/16"	0.05 mm
1/8"	0.10 mm
1/4"	0.10 mm OD
	0.20 mm ID

PTFE	
Tubing OD	OD and ID (±)
1/16"	0.05 mm
1/8"	0.10 mm
1/4"	0.10 mm
1/2"	0.20 mm

FRIT VOLUME

STAINLESS, TITANIUM, AND POLYMER FRITS

Internal frit volumes are theoretical and are calculated by multiplying the total frit volume by the proportion of the pores in the frit (porosity proportion). Stated frit porosities are only nominal and do not select the maximum pore size of a frit. The chart below will help you in selecting the right frit for your application.

Porosity in µm	Max pore size in µm	Particles retained in µm	Porosity in %
0.2	1	≥ 1.0	22
0.5	2	≥ 1.5	26
1	3	≥ 3.0	30
2	5	≥ 3.5 - 5.0	35
5	15	≥ 15.0	38
10	30	≥ 30	40

STANDARD THREADS

Following are illustrations of standard threads for VICI Jour fittings. Place your fitting on the drawings below to identify the thread size.

2-56	6-40	10-32	5/16-24	1/4-28	1/2-20
for 360 µm OD tubing	for 1/32" OD tubing	for 1/16" OD tubing	for 1/8" OD tubing	for 1/16" and 1/8" OD tubing	for 1/4" OD tubing



GENERAL REFERENCE

CHEMICAL RESISTANCE OF PEEK AT HIGH TEMPERATURE

Chemical	°C	°F	Rating
Acetic acid	200	420	■
Ammonia gas	200	420	■
Carbon monoxide gas	200	420	■
Ethylene glycol	200	420	■
Ethylene glycol (50%)	140	284	■
Hydrogen sulphide gas	200	420	■
Liquid ammonia	200	420	■
Methane	200	420	■
Methylethylketone	200	420	■
Nitrobenzene	200	420	■
Phosphoric acid (50%)	200	420	■
Sodium hydroxide solution	200	420	■
Sulphuric acid (50%)	200	420	■
Sulphur dioxide gas	200	420	■

CHEMICAL CHARACTERISTICS OF PEEK®

PEEK exhibits excellent resistance to a wide range of organic and inorganic chemicals. The compatibility of PEEK with many chemicals at 20°C (68°F) has been investigated and the results for unreinforced grades are given in the table below.

PEEK is compatible with almost any of the solvents used in HPLC. The only solvents which will attack PEEK are concentrated nitric acid and sulphuric acids. However, PEEK tubing can safely withstand 20-30% nitric acid when passivating a system.

Methylene chloride, DMSO, and THF may cause swelling in PEEK. The highest temperature we recommend for PEEK is 100°C. The tubing will maintain the stated pressure rating up to this temperature.

CHEMICAL RESISTANCE OF PEEK AND OTHER POLYMERS

A

Resistance at 20°C	PEEK	PA	PE	PP	PPS	FEP	ETFE	PFA	PTFE	NBR	EPDM	PCTFE
Acetaldehyde	■	■	-	-	-	■	-	■	-	■	■	-
Acetic acid (20 %)	■	■	■	■	■	■	■	■	■	■	■	-
Acetic acid (80 %)	■	■	■	■	■	■	-	■	■	-	-	-
Acetic acid (glacial)	■	■	■	■	■	■	■	■	■	■	■	-
Acetone	■	■	■	■	■	■	■	■	■	■	■	■
Acetonitrile	■	■	-	-	■	■	■	■	■	■	■	■
Acrylic acid	■	-	-	-	■	■	-	■	-	-	-	-
Ammonia, anhydrous	■	■	-	-	■	■	-	■	-	-	-	■
Ammonia (10 %)	■	■	■	■	■	■	■	■	■	-	-	■
Ammonia (Liquid)	■	■	-	-	■	■	-	■	-	-	-	■
Ammonium hydroxide	■	-	■	■	■	■	■	■	■	-	-	-
Aqua regia	■	■	-	-	■	■	-	■	-	■	■	■
Aromatic hydrocarbons	■	-	■	■	■	■	-	■	-	-	-	■

B

Resistance at 20°C	PEEK	PA	PE	PP	PPS	FEP	ETFE	PFA	PTFE	NBR	EPDM	PCTFE
Benzene	■	■	■	■	■	■	■	■	■	-	-	■
Benzoic acid	■	-	-	-	■	■	-	■	-	-	-	-
Benzaldehyde	■	-	-	-	■	■	-	■	-	-	-	■
Bromine/dibromoethane	■	-	-	-	■	■	-	■	-	-	-	-
Bromine (dry)	■	-	-	-	■	■	-	■	-	-	-	-
Bromine (wet)	■	■	-	-	■	■	-	■	-	■	■	■
Boric acid	■	-	-	-	■	■	-	■	-	-	-	■
Butanol	■	-	■	■	■	■	■	■	■	-	-	■

LEGEND

- Suitable
- Marginal; dependent on application
- Not recommended
- No data available



C

Resistance at 20°C	PEEK	PA	PE	PP	PPS	FEP	ETFE	PFA	PTFE	NBR	EPDM	PCTFE
Calcium hydroxide	■	-	-	-	■	■	-	■	-	-	-	-
Carbon tetrachloride	■	-	-	-	■	■	-	■	-	-	-	-
Chlorine (gas)	■	■	-	-	■	■	-	■	-	■	■	■
Chlorine (liquid)	■	■	-	-	■	■	-	■	-	-	-	-
Chloroacetic acid	■	-	□	□	■	■	■	■	■	-	-	-
Chlorobenzene	■	■	-	-	■	■	-	■	-	-	-	-
Chloroform	■	■	□	□	■	■	■	■	■	-	-	□
Cyclohexane	■	■	□	■	■	■	■	■	■	-	-	-
Cyclohexanone	■	■	■	■	■	■	■	■	■	■	■	-

D

Resistance at 20°C	PEEK	PA	PE	PP	PPS	FEP	ETFE	PFA	PTFE	NBR	EPDM	PCTFE
Diethylamine	■	-	■	■	-	■	■	■	■	-	-	-
Diethylether	■	■	-	-	■	■	-	■	-	-	-	-
Diethylformamide	■	■	■	■	■	■	■	■	■	■	■	-
Dioxane	■	■	-	-	■	■	■	■	-	-	-	-

E

Resistance at 20°C	PEEK	PA	PE	PP	PPS	FEP	ETFE	PFA	PTFE	NBR	EPDM	PCTFE
Ethanol	■	■	□	■	■	■	■	■	■	■	■	■
Ether	■	■	□	■	■	■	■	■	■	-	-	□
Ethyl acetate	■	■	□	■	■	■	■	■	■	■	■	■
Ethylene chloride	-	■	□	□	■	■	■	■	■	-	-	■
Ethylene glycol	■	■	■	■	■	■	■	■	■	■	■	■

H

Resistance at 20°C	PEEK	PA	PE	PP	PPS	FEP	ETFE	PFA	PTFE	NBR	EPDM	PCTFE
Heptane	■	□	□	□	■	■	■	■	■	■	■	-
Hexane	■	■	□	□	■	■	■	■	■	-	-	■
Hydrobromic acid (100%)	■	-	□	□	■	■	-	■	■	-	-	-
Hydrobromic acid (20%)	■	-	□	■	-	■	■	■	■	-	-	■
Hydrochloric acid (100%)	■	-	-	□	■	■	■	■	■	-	-	■
Hydrochloric acid (20%)	■	-	■	□	■	■	■	■	■	-	-	■
Hydrofluoric acid (100%)	■	-	-	□	■	■	■	■	■	-	-	-
Hydrofluoric acid (20%)	-	-	■	■	■	■	■	■	■	-	-	■
Hydrogen peroxide (100%)	■	-	□	□	■	■	-	■	■	-	-	-
Hydrogen peroxide (50%)	■	-	□	□	-	■	■	■	■	-	-	-
Hydrogen peroxide (10%)	■	-	■	■	■	■	■	■	■	-	-	-

I

Resistance at 20°C	PEEK	PA	PE	PP	PPS	FEP	ETFE	PFA	PTFE	NBR	EPDM	PCTFE
Iso-octane	■	-	-	■	■	■	-	■	■	-	-	-
Isopropanol	■	□	■	■	■	■	-	■	■	□	■	■
Isopropyl ether	-	■	■	□	-	■	-	■	■	-	-	-

K

Resistance at 20°C	PEEK	PA	PE	PP	PPS	FEP	ETFE	PFA	PTFE	NBR	EPDM	PCTFE
Ketones	■	-	□	□	■	■	-	■	■	-	-	■

Chemical resistance • PEEK and other polymers



GENERAL REFERENCE

M

Resistance at 20°C	PEEK	PA	PE	PP	PPS	FEP	ETFE	PFA	PTFE	NBR	EPDM	PCTFE
Methanol	■	■	■	■	■	■	■	■	■	■	■	■
Methyl dichloride	-	□	-	■	-	■	-	■	-	-	-	-
Methyl ethylketone	■	■	□	□	■	■	■	■	■	-	-	□
Methylene chloride	□	□	□	□	■	■	■	■	■	■	■	□

N

Resistance at 20°C	PEEK	PA	PE	PP	PPS	FEP	ETFE	PFA	PTFE	NBR	EPDM	PCTFE
Nitric acid (100%)	■	-	□	■	■	■	■	■	■	-	-	■
Nitric acid (20%)	■	-	□	■	■	■	■	■	■	-	-	■

P

Resistance at 20°C	PEEK	PA	PE	PP	PPS	FEP	ETFE	PFA	PTFE	NBR	EPDM	PCTFE
Pentane	■	-	■	■	-	■	-	■	■	-	-	-
Perchloric acid	■	-	□	□	-	□	□	□	■	-	-	-
Phenol (dilute)	■	-	-	-	■	■	-	■	-	-	-	-
Phenol (concentrated)	■	-	-	-	■	■	-	■	-	-	-	-
Phosphoric acid (100%)	■	-	□	■	■	■	■	■	■	-	-	-
Phosphoric acid (40%)	■	-	■	■	■	■	■	■	■	-	-	-
Potassium hydroxide (dilute)	■	-	-	-	■	■	-	■	-	-	-	■
Potassium hydroxide (70%)	■	-	-	-	■	■	-	■	-	-	-	-
Propanol	■	□	-	-	-	■	-	■	-	■	■	-
Pyridine	■	-	□	■	■	■	■	■	■	-	-	-

S

Resistance at 20°C	PEEK	PA	PE	PP	PPS	FEP	ETFE	PFA	PTFE	NBR	EPDM	PCTFE
Sodium hydroxide (80%)	■	□	□	■	■	■	-	■	■	-	-	■
Sodium hydroxide (20%)	■	□	■	■	■	■	■	■	■	-	-	■
Sulfuric acid (100%)	■	■	□	□	■	■	■	■	■	-	-	-
Sulfuric acid (75%)	■	□	■	■	■	■	■	■	■	-	-	-
Sulfuric acid (40%)	■	■	■	■	■	■	■	■	■	-	-	-

T

Resistance at 20°C	PEEK	PA	PE	PP	PPS	FEP	ETFE	PFA	PTFE	NBR	EPDM	PCTFE
Tetrahydrofuran	□		□	□	■	■	■	■	■	-	-	□
Toluene	■		□	□	■	■	■	■	■	-	-	-
Trichloroacetic acid	■		■	■	■	■	■	■	■	-	-	-
Trichloroethane	■		-	□	-	■	-	■	■	-	-	-
Trichloroethylene	■		-	-	■	■	-	■	-	-	-	-
Triethylamine	-		-	■	-	■	■	■	■	-	-	-

W

Resistance at 20°C	PEEK	PA	PE	PP	PPS	FEP	ETFE	PFA	PTFE	NBR	EPDM	PCTFE
Water	■	■	■	■	■	■	■	■	■	■	■	■
Water (distilled)	■	-	■	■	■	■	■	■	■	-	-	■

X

Resistance at 20°C	PEEK	PA	PE	PP	PPS	FEP	ETFE	PFA	PTFE	NBR	EPDM	PCTFE
Xylene	■	-	-	-	■	■	-	■	-	-	-	□

LEGEND

- Suitable
- Marginal; dependent on application
- Not recommended
- No data available



PROPERTIES OF POLYMERS

CTFE / PCTFE

Polychlorotrifluoroethylene, abbreviated as CTFE or PCTFE, is the generic name for the material produced as Kel-F®. CTFE/PCTFE features high tensile strength and good chemical resistance. It is nonflammable, with heat resistance up to 175°C. The presence of a chlorine atom, which has a greater atomic radius than fluorine, results in a melting point of ~210 - 215°C – relatively low for a fluoropolymer. CTFE/PCTFE is resistant to attack by most chemicals and oxidizing agents; however, it swells slightly in halocarbon compounds, ethers, esters, and aromatic solvents.

EPDM

Ethylene Propylene Diene Monomer. Ethylene-propylene synthetic rubbers offer excellent heat resistance as well as resistance to aging from oxidation, ozone, and weather due to their stable, saturated polymer backbone structure. As non-polar elastomers, they have good electrical resistivity as well as resistance to polar solvents such as water, acids, alkanes, phosphates, esters, and many ketones and alcohols.

ETFE

Ethyltrifluoroethylene is the generic name for the material such as Tefzel®. A fluoropolymer used for sealing surfaces, it is resistant to most chemical attack; however, some chlorinated chemicals will cause a physical swelling of ETFE tubing.

FEP

Fluorinated ethylene propylene is another member of the fluorocarbon family with similar chemical properties. It is generally more rigid than PTFE, with somewhat increased tensile strength. It is typically more transparent than PTFE, slightly less porous, and less permeable to oxygen. FEP is not as subject to compressive creep at room temperature as PTFE, and because of its slightly higher coefficient of friction is easier to retain in a compression fitting.

FFKM

FFKM (perfluorinated rubber) is a perfluoroelastomer, a class of materials such as Kalrez®. It is chemically resistant to polar solvents, organic solvents, inorganic and organic acids and bases, fuels, oils, lubricants, inorganic salts, aldehydes, metal halogen compounds, chlorine, sodium hydroxide, aromatics, alcohols, steam, and strong oxidizing agents. The normal temperature service range is -40°C to 315°C, with up to 343°C in intermittent service.

PEEK™

Considered relatively inert and biocompatible, polyetheretherketone tubing can withstand temperatures up to 100°C. Under the right circumstances, .005" - .020" ID tubing can be used up to 5000 psi for a limited time, and 0.030" to 3000 psi. Larger IDs are typically good to 500 psi. These limits will be substantially reduced at elevated temperatures and in contact with some solvents or acids.

Its mechanical properties allow PEEK to be used instead of stainless in many situations and in some environments where stainless would be too reactive. However, PEEK can be somewhat absorptive of solvents and analytes, notably methylene chloride, DMSO, THF, and high concentrations of sulfuric and nitric acid. This tubing is highly prone to "kinking", or sealing off, if held in a sharp bend over time.

PEEK-HT / PEK

PEEK-HT or PEK, like PEEK™, belongs to the class of PolyArylEtherKetones (PAEK). This class of semi-crystalline high performance engineering thermoplastics exhibits a unique combination of thermal stability, chemical resistance, and excellent mechanical properties over a wide temperature range. In comparison to PEEK, PEEK-HT provides better thermal stability and higher rigidity, which establishes more extensive processing and better durability under compression load.

PFA

Perfluoroalkoxy is a fluorocarbon with chemical and mechanical properties similar to FEP. More rigid than either PTFE or FEP. Commonly used for injection molded parts.

Continued, next page.



GENERAL REFERENCE

PPS

Polyphenylene sulphide is the generic name for the material produced as Fortron[®], Ryton[®], and Techtron[®]. It is very resistant to all solvents, acids, and bases.

PTFE

Polytetrafluoroethylene is the generic name for the class of materials such as Teflon[®]. It offers superior chemical resistance but is limited in pressure and temperature capabilities. Because it's so easy to handle, it is often used in low pressure situations where stainless steel might cause adsorption. PTFE tubing is relatively porous, and compounds of low molecular weight can diffuse through the tubing wall.

POLYACETAL

Polyacetal or polyoxymethylene (POM) is the generic name for the material produced as Delrin[®]. It is an engineering polymer with high mechanical strength and rigidity, excellent dimensional stability and excellent resistance to moisture and solvents. It has a wide useful temperature range in air of -50°C to +90°C. It is not suitable for use with acids, alkalis, or oxidizing agents, and has limited resistance to dichloromethane and methyl ethyl ketone.

POLYAMIDE

Polyamide is a thermoplastic polymer also known as nylon. Nylon has very good physical properties, but moisture can have a significant effect. It exhibits very good heat resistance and excellent chemical and wear resistance.

POLYETHYLENE

Polyethylene is a semi-crystalline material with excellent chemical resistance, plus good fatigue and wear resistance. Polyethylenes provide good resistance to organic solvents and staining, and have low moisture absorption rates.

POLYPROPYLENE

Widely used polymer for non-wetted parts. Attacked by strong oxidizers as well as aromatic and chlorinated hydrocarbons.

PVDF

PVDF, or polyvinylidene fluoride, has excellent resistance to most mineral and organic acids, aliphatic and aromatic hydrocarbons, and halogenated solvents. Poor resistance to acetone, MEK, THF, and potassium and sodium hydroxide. Often supplied as Kynar[®].

PROPERTIES OF METALS

STAINLESS STEEL, TYPE 316

This is the standard tubing material for chromatography, suitable for a wide variety of applications. It is cold drawn seamless, not welded, with close tolerances held on both ID and OD. We neither recommend nor offer Type 304 stainless steel for analytical applications.

Austenitic stainless steels may be used for most chromatographic applications. Type 316 is most commonly used for HPLC because of its superior chloride ion resistance.

STAINLESS STEEL, TYPE 303

Recommended for GC use and general purpose connections, combining excellent machining characteristics with good resistance to corrosion and high temperature oxidation. Susceptible to attack by chlorides, iodides, and bromides.

TITANIUM

Although it is more difficult to machine than common alloys containing aluminum and vanadium, VICI uses Grade 2 pure titanium in order to avoid possible contamination of the sample stream with these metals. Good for organic and inorganic salts except aluminum and calcium chlorides, and all alkalis except boiling concentrated potassium hydroxide.

Good with dilute, low temperature formic, lactic, sulfuric, hydrochloric, and phosphoric acids, but rapidly attacked by hydrofluoric acid. Good with dilute nitric acid at low temperatures; corrodes at high concentrations and temperatures. Can ignite with fuming nitric acid. Attacked by oxalic acid, concentrated phosphoric acid, hot trichloroacetic acid, and zinc chloride.



SAFETY

- 1. Never tighten or loosen a fitting or valve connection while it is pressurized. Provisions should be made within the system to release pressure via suitable valve components.
- 2. Do not exceed pressure or temperature specifications. Note that in many cases, the system pressure is limited by the tubing used, not the fittings.
- 3. The use of toxic or hazardous fluids requires extra caution during operation or maintenance. The user is responsible for insuring safe operation and for understanding the nature of the fluids and chemistry involved.
- 4. The use of thread lubricants or sealants is required only on tapered pipe threads. These sealants and lubricants may have different temperature limits or chemical compatibility than the valves or fittings.

TRADEMARKS

Trademarks of materials and products found in VICI Jour products or referred to in this website. Please contact us regarding errors, omissions, or discrepancies.

Cheminert®	Valco Instruments Co. Inc. and VICI AG International
Delrin®	E.I. duPont de Nemours
Duran®	Schott AG
Fortron®	Fortron Industries LLC
Kalrez®	DuPont Dow Elastomers
Kel-F®	3M Company
Kynar®	Elf Atochem North America Inc.
Nanovolume®	Valco Instruments Co. Inc.
PEEK™	Victrex plc
PEEK HT™	Victrex plc
Rheodyne®	Rheodyne LLC
Ryton®	Chevron Phillips Chemical Company LLC
SCAT®	SCAT-Europe GmbH
Techtron®	Quadrant Engineering Plastic Products
Teflon®	E.I. duPont de Nemours
Valco®	Valco Instruments Co. Inc.
VICI®	Valco Instruments Co. Inc. and VICI AG International
VICI Jour®	Valco Instruments Co. Inc. and VICI AG International

CAUTION

The improper selection or use of components or systems described herein can cause personal injury or property damage.

The system designer and user are solely responsible for the selection of products suitable for the specific requirements of the application, as well as proper installation, operation, and maintenance of these products.

Compatibility with hazardous fluid streams, environmental conditions, and mechanical requirements are the responsibility of the user.



A

ADAPTER

A type of fitting which provides a method of joining two components of differing thread types or systems.

ANALYTICAL COLUMN

A long narrow tube packed or coated with one of many available chemically diverse compounds that can separate the components in a sample according to their boiling point, polarity, molecular size, or combination thereof. A column of some kind is used with most chromatographic techniques.

B

BIOCOMPATIBILITY

Defines the materials used in a system (i.e. fittings, tubing, and valves) that do not change the bioactivity of the biological substances that come into contact with the surface of these materials. Note that in chromatographic systems, the tubing and column contribute over 99% of the surface area and the valves and fittings are insignificant.

BORE

The diameter of the minimum orifice through the fitting. See capillary bore, through-type bore, and large bore.

BULKHEAD FITTING

A type of fitting in which the fitting body is inserted through an instrument panel or mounting bracket, to which it is affixed with a mounting nut. The Valco fitting body is uniquely undercut so that it "bites" into the panel when the mounting nut is tightened, eliminating the need for a lock washer.

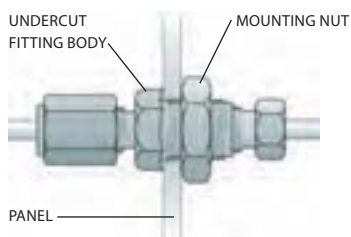
**BUTT CONNECTION**

A type of connection in which the two tube ends are directly and squarely in contact, usually effected with a through-type union. Typically used with fused silica connections, or small bore metal tubing.

C

CAP

A cap is used to dead-end a piece of tubing with a nut and ferrule attached.

CAPILLARY BORE

The smallest available standard orifice in a given fitting design (usually 0.25 mm). Typically denoted by suffix "C" in the product number.

COLLAPSIBLE FERRULE

A one-piece ferrule engineered to collapse as it is tightened. The collapse takes place in two very narrow areas, and results in a very effective seal with virtually no distortion of the tubing ID and no dead volume. Patent No. 6,575,501

COMPRESSION FITTING

A style of fitting in which a threaded nut compresses a tapered ferrule onto tubing as the nut is tightened. Valco metal ferrules cut a ring into the tubing wall while polymer types rely on surface compression to form a seal.

CONNECTING VOLUME

The volume between two or more connections. This may be cleanly swept, thus not contributing to peak distortion, or may be "dead volume" such as that found in fittings with larger bores than the connecting tubing.

CROSS

A type of distribution fitting which connects four pieces of tubing, arranging them in the pattern of a cross.

D

DEAD VOLUME

Any volume which a component introduces to a system that is not cleanly swept and relies on diffusion to clear the space. See connecting volume.

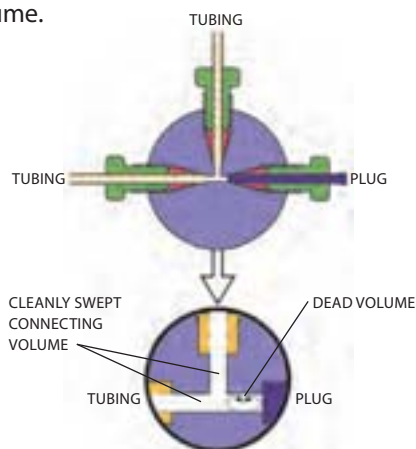

**DETAIL**

See *fitting detail*.

DISTRIBUTION FITTING

A generic term for tees, crosses, and manifolds, used to provide multiple access points to “distribute” a gas or liquid through a system. CAUTION! Using a distribution fitting in reverse to coalesce multiple streams may create dead volume. Special manifolds are available for this application.

F**FIA**

Flow Injection Analysis.

A simple and versatile analytical technique for automating wet chemical analyses based on the manipulation of a sample zone formed from the injection of the sample into a continuous stream of fluid used as a carrier.

FEMALE NUT

A nut with female threads; also called external nut.

FERRULE

One of the components of a compression fitting; the conical piece of metal or plastic that compresses onto the tube as it is forced into a tapered seat. Valco metal ferrules are unique in that they attach to and seal at the tube by cutting a shallow ring into it, instead of by actually swaging it. This is preferable since it introduces no flow restriction.

FILTER

A type of union or reducing union which traps the particulates in a stream. The filtering element is typically a mesh screen or sintered frit.

FINGERTIGHT FITTING

A fingertight fitting is a knurled or winged nut which is hand tightened to compress the ferrule. Note: Polymeric ferrules rely on surface compression to form a seal and hold the tube by friction.

FITTING DETAIL

A fitting detail includes the thread to accept the nut, a tapered ferrule seat, and the pilot for the tube. The nut, ferrule, and tube go into the fitting detail to make the seal.

Valco fitting details have the perfect shape, with a smooth transition from the ferrule seat into the cylindrical and threaded part. Many other fitting details are poor in design where the ferrule is forced in a too shallow ferrule seat. The result is a “nicked” ferrule which can no longer apply its sealing force to the front of the ferrule.

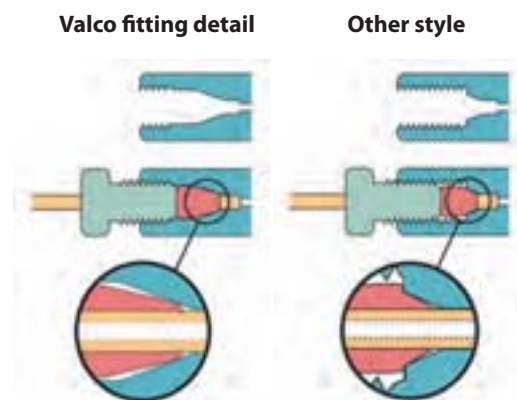
**FLANGED FITTING**

A type of fitting used with fluoropolymer tubing (PTFE, FEP) in which a flange is made at the tube end. Connections are made at the flange either by compressing the flange into a flat detail (typically 1/4-28 threaded) or by butting two flanges together. A special flanging tool forms the flanges.

FLANGELESS FITTING

Similar in application to the flanged fitting, but the flange is not required. A ferrule system is used which grips/compresses the tube. This fitting type can be used with virtually any polymeric tubing since the tube end does not have to be formed, but simply square cut. Typically used in 1/4-28 threaded fittings, it is usually interchangeable with flanged fittings.

FRIT

A filter element typically made of stainless, Hastelloy, Titanium, or polymers, usually 0.75 mm or 1 mm thick. Frits may provide better filtration than screens, but because they are thicker there is greater mixing potential, and they typically result in increased pressure drop.

**G****GC**

Gas Chromatography.

An analytical method incorporating an injection system, analytical column, controlled temperature zone, and detector. An inert carrier gas moves the sample through the column, which separates the sample components into discrete bands which are measured as they pass through the detector.

GUARD COLUMN

A column used in series between the injector and analytical column to prevent certain types of components from entering the analytical column.

H**HPLC**

High Performance Liquid Chromatography.

An analytical system consisting of an injector, pump, analytical column, and detector. Using a liquid mobile phase, the sample is pumped through the column, where it is separated into discrete sample component bands which are detected and measured as the bands elute from the column.

I**ID**

Internal diameter.

INERT

Technically, unreactive with other substances; however, in the instrumentation field, "inert" is a relative term. Often polymers are termed inert but are soluble in some fluids and can react with some compounds.

INTERNAL FITTING

A type of compression fitting in which the fitting body has female threads; an internal nut has male threads.

L**LC**

Liquid Chromatography.

Any of a variety of low to medium pressure techniques which use a liquid mobile phase as the carrier to move sample. Similar to HPLC.

LARGE BORE

A bore that is larger than the standard for a given fitting; a fitting ordered with a large bore will have a larger flow orifice than the standard or capillary bore fitting of the same design. Denoted by suffix "L" in the product number.

LUER ADAPTER

An adapter that connects a tapered luer fitting (square nib) of a syringe to a tube or tube fitting.

M**MALE NUT**

A nut with male threads.

MAKE UP

The point at which a ferrule, nut, and tube are assembled in the fashion which will effect a leak-free seal. In most compression fittings, that is accomplished by compressing the tube with the small end of the ferrule. With Valco metal ferrules, the ferrule usually makes up on the tube by cutting a shallow ring in it.

MANIFOLD

A type of distribution fitting in which a single source is directed to multiple outlets, or vice versa. Caution! Using a common distribution fitting in reverse to merge multiple streams may create dead volume. Special manifolds are available for this application.

MICROBORE COLUMN

A liquid chromatography column of narrow bore (typically 2 mm or less) for improved resolution.

N**NPT**

National Pipe Thread; a standardized tapered pipe fitting. See pipe thread.

NANOBORE

Nanobore generally refers to components with bore sizes less than 250 μm (0.010").

NANOVOLUME®

The trademark registered to Valco Instruments Co. Inc. and VICI AG International, applied to our nanobore components with bore sizes less than 250 μm (0.010").

**NUT**

The tensioning component of a compression fitting. As the threaded nut is tightened into the fitting detail, it pushes the ferrule forward into the tapered ferrule seat, causing it to make up on the tube.

O**OD**

Outside diameter.

ONE-PIECE FINGERTIGHT

A one-piece fingertight fitting is a knurled or winged nut with integrated ferrule. It is convenient to use since the ferrule is retrieved from the port with the nut.

Note: Polymer type ferrules rely on surface compression to form a seal and hold the tube by friction.

P**PILOT**

The tubing which extends beyond the ferrule in a made-up fitting, or the integral portion of a ZRF internal reducing ferrule which extends beyond the ferrule. See also pilot depth, below.

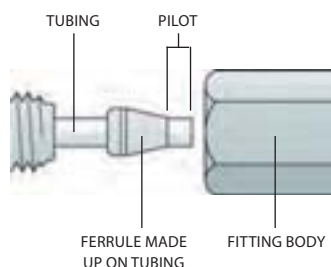
**PILOT DEPTH**

The length of the tubing diameter cavity beyond the tapered ferrule seat within a fitting detail. Valco fitting pilot depths are tightly controlled to facilitate the interchangeability of components without the risk of leaks or dead volume.

PIPE THREAD

The external or internal threads of a fitting designed to effect a metal-to-metal seal on the conical thread faces. This type of fitting does not “bottom out” in the detail. Typically used with PTFE tape or other compound to lubricate the threads; however, since the diffusion rate of air components through the PTFE tape is considerable, pipe fittings should not be used in systems where leakage rates are critical.

PLUG

A plug is used to block a fitting detail in a union, tee, cross, or valve.

R**REDUCING FERRULE**

A ferrule which allows a smaller tube to be used in a fitting detail designed for a larger tube. Caution should be taken if standard reducing ferrules without integral pilots are used, since dead volume may be created in the fitting pilot depth.

REDUCING UNION

A fitting which joins two tubes of different ODs. The bore of the fitting should typically match the ID of the smaller tube.

S**SFE**

Supercritical Fluid Extraction.

An extraction technique using a fluid in its supercritical state as the extraction medium. Some liquids and mixtures maintained above a critical temperature and pressure exhibit properties of both the liquid and gas phases of the element. These are defined as supercritical. CO₂ is a common supercritical fluid. Extreme caution must be used with supercritical CO₂, since uncontrolled expansion (leaks) can be very hazardous due to the substantial stored energy.

SFC

Supercritical Fluid Chromatography.

An analytical technique using a supercritical fluid (see SFE) as the mobile phase/carrier.

STANDARD BORE

A bore which was chosen as the standard for a particular fitting, typically based on the most common tubing ID used with that fitting.



T

TEE

A type of distribution fitting which connects three pieces of tubing, arranging them in the pattern of a "T".

THROUGH-TYPE BORE

A bore which is slightly larger than the OD of the tubing which is used with the given fitting. A union with a through-type bore allows the tube ends to butt directly together, or for one tube to run completely through the fitting. Denoted by suffix "T" in the product number. In order to assure correct pilot lengths, we recommend that ferrules be made up on the tubing in a standard union.

U

UNION

A fitting for connecting two pieces of tubing of the same OD.

See also reducing union.

Female union

A type of compression fitting in which the fitting body has female threads. Also referred to as internal union.

Male union

A type of compression fitting in which the fitting body has male threads. Also referred to as external union.

UNSWEEP VOLUME

The volume of any portion of a fitting which is in the flowpath but which is a different diameter than the primary flow orifice through the tubing/fitting assembly, or any area not directly swept by the fluid flow. This can also be known as "dead volume" if it is very poorly swept.

V

VICI

VICI® is an acronym for Valco Instruments Company Inc.

VICI now defines multiple companies which manufacture various products for the analytical industry.

W

WETTED SURFACES

The surfaces which are contacted by the sample stream.

Y

Y ("WYE")

A type of distribution fitting which connects three pieces of tubing, arranging them in the pattern of a "Y". Occasionally referred to as a "wye".

Z

ZDV

Zero dead volume. See definition below.

ZERO DEAD VOLUME

Describes a connection which does not add volume to the system beyond what an extension of tubing would in its place.

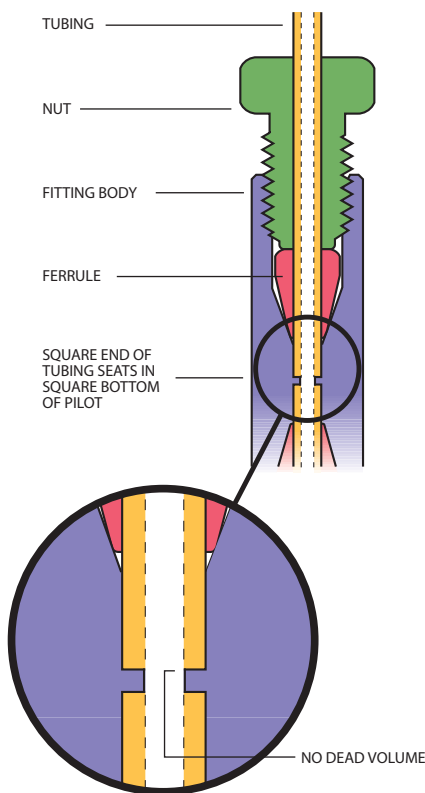
**ZERO VOLUME**

While often used interchangeably with zero dead volume, it ideally describes a fitting design in which there is no internal volume, such as a through-type union designed to butt-fit two pieces of tubing.



TEMPERATURE CONVERSIONS

°C	°F	°C	°F	°C	°F	°C	°F	°C	°F
-40	-40	65	149	170	338	275	527	500	932
-35	-31	70	158	175	347	280	536	525	977
-30	-22	75	167	180	356	285	545	550	1022
-25	-13	80	176	185	365	290	554	575	1067
-20	-4	85	185	190	374	295	563	600	1112
-15	5	90	194	195	383	300	572	625	1157
-10	14	95	203	200	392	305	581	650	1202
-5	23	100	212	205	401	310	590	675	1247
0	32	105	221	210	410	315	599	700	1292
5	41	110	230	215	419	320	608	725	1337
10	50	115	239	220	428	325	617	750	1382
15	59	120	248	225	437	330	626	775	1427
20	68	125	257	230	446	335	635	800	1472
25	77	130	266	235	455	340	644	825	1517
30	86	135	275	240	464	345	653	850	1562
35	95	140	284	245	473	350	662	875	1607
40	104	145	293	250	482	375	707	900	1652
45	113	150	302	255	491	400	752	925	1697
50	122	155	311	260	500	425	797	950	1742
55	131	160	320	265	509	450	842	975	1787
60	140	165	329	270	518	475	887	1000	1832

LENGTH

µm	inches
100	.004"
150	.006"

mm	inches
0.050	.002"
0.064	.0025"
0.075	.003"
0.100	.004"
0.13	.005"
0.15	.006"
0.18	.007"
0.20	.008"
0.25	.010"
0.38	.015"
0.40	.016"
0.50	.020"
0.75	.030"
1.00	.039"
1.50	.059"
2.00	.079"
3.00	.118"
4.00	.157"
4.60	.181"
6.00	.236"
6.35	.250"
6.40	.252"
7.00	.276"
10.00	.394"
12.70	.500"

inches	mm
1/32"	0.79
1/16"	1.59
3/32"	2.38
1/8"	3.18
1/4"	6.35
5/16"	7.94
3/8"	9.50
1/2"	12.70
1"	25.40

feet	mm
1 ft	304.8

PRESSURE CONVERSIONS

bar	psi	kPa	MPa
0.1	1.5	10	0.01
0.2	2.9	20	0.02
0.3	4.4	30	0.03
0.4	5.8	40	0.04
0.5	7.3	50	0.05
0.6	8.7	60	0.06
0.7	10.2	70	0.07
0.8	11.6	80	0.08
0.9	13.1	90	0.09
1	14.5	100	0.1
2	29.0	200	0.2
3	43.5	300	0.3
4	58.0	400	0.4
5	72.5	500	0.5

bar	psi	kPa	MPa
6	87.0	600	0.6
7	101.5	700	0.7
8	116.0	800	0.8
9	130.5	900	0.9
10	145	1,000	1
20	290	2,000	2
30	435	3,000	3
40	580	4,000	4
50	725	5,000	5
60	870	6,000	6
70	1,015	7,000	7
80	1,160	8,000	8
90	1,305	9,000	9

bar	psi	kPa	MPa
100	1,450	10,000	10
200	2,900	20,000	20
300	4,350	30,000	30
400	5,800	40,000	40
500	7,250	50,000	50
600	8,700	60,000	60
700	10,150	70,000	70
800	11,600	80,000	80
900	13,050	90,000	90
1,000	14,500	100,000	100
1,100	15,950	110,000	110
1,200	17,400	120,000	120
1,300	18,850	130,000	130

Index by product number



GENERAL REFERENCE

JR-5FR1-5.....87	JR-1065.....50	JR-2FR8-5.....87	JR-55088-10.....23	JR-794.....100	JR-CBUMPK.....50	JR-S-16113.....77
JR-5FR1TI-5.....87	JR-1066.....32	JR-2FR8TI-5.....87	JR-55088-5.....23	JR-795.....100	JR-CBCKP-1.....31	JR-S-16152.....82
JR-5FR2-5.....87	JR-1067.....32	JR-32171.....59	JR-55089-10.....23	JR-796.....101	JR-C-EN.5FPKB.....43	JR-S-18004.....76
JR-5FR4-5.....87	JR-1068.....50	JR-32172.....59	JR-55089-5.....23	JR-797.....100	JR-C-EN1FPKB.....43	JR-S-18014.....76
JR-5FR6-5.....87	JR-10FR1-5.....87	JR-32174.....59	JR-5508X-12.....23	JR-798.....100	JR-CFE-S10-5.....56	JR-S-18053.....82
JR-5FR8-5.....87	JR-10FR1K-5.....87	JR-32178.....59	JR-5508X-24.....23	JR-800.....102	JR-CFE-S2-5.....56	JR-S-18304.....78
JR-031-10.....47	JR-10FR2-5.....87	JR-32179.....59	JR-55090-10.....23	JR-8000-0495-10.....61	JR-CFE-S75-5.....56	JR-S-18314.....78
JR-032-10.....47	JR-10FR4-5.....87	JR-357090.....100	JR-55090-5.....23	JR-8000-0495-2.....61	JR-CFL-2W-5.....51	JR-S-18353.....82
JR-040BK-10.....48	JR-10FR6-5.....87	JR-357180.....100	JR-55091-10.....23	JR-8000-0495-20.....61	JR-CFL-4D.....79	JR-S-20002.....68
JR-040BL-10.....48	JR-10FR8-5.....87	JR-367008-10.....61	JR-55091-5.....23	JR-802.....101	JR-CFL-4PPS.....51	JR-S-20004.....67
JR-040GR-10.....48	JR-10FR8TI-5.....87	JR-367008-2.....61	JR-55100-5.....23	JR-804.....103	JR-CFLAPK.....35	JR-S-20005.....68
JR-040RE-10.....48	JR-1100-05P-5.....88	JR-367008-20.....61	JR-5510-5.....29	JR-805.....103	JR-CFL-CB1KF.....47	JR-S-20009.....74
JR-040WH-10.....48	JR-1100-2P-5.....88	JR-367016-10.....61	JR-55110-5.....23	JR-80-5.....41	JR-CFL-CB1PK.....47	JR-S-20100.....85
JR-040WL-10.....48	JR-1101-05P-5.....88	JR-367016-2.....61	JR-5511-5.....29	JR-9.....92	JR-CFL-CB2KF.....47	JR-S-20200.....85
JR-040YL-10.....48	JR-1101-2P-5.....88	JR-367016-20.....61	JR-5513-5.....26	JR-9000-0005.....84	JR-CFL-CB2PK-5.....51	JR-S-31.....74
JR-041-10.....47	JR-1102-05P-5.....88	JR-3675-2.....61	JR-5518-5.....26	JR-9000-0007.....83	JR-CFL-CB4KF-5.....51	JR-S-32.....74
JR-042-10.....51	JR-1102-2P-5.....88	JR-3678-2.....61	JR-5520N-10.....23	JR-9000-0010.....84	JR-CM1XPK.....53	JR-S-35.....68
JR-049-10.....47	JR-1103-05P-5.....88	JR-3678-25.....61	JR-5525N-10.....25	JR-9000-0011.....84	JR-CM2XPK.....53	JR-S-35L.....68
JR-050BK-10.....48	JR-1103-2P-5.....88	JR-4071-10.....93	JR-5570-5.....28	JR-9000-0012.....84	JR-CMLAPK.....35	JR-S-40004.....68
JR-050BL-10.....48	JR-1104-05P-5.....88	JR-4072-10.....93	JR-5575.....35	JR-9000-0013.....83	JR-C-NEUR1FPK.....43	JR-S-40007.....79
JR-050GR-10.....48	JR-1104-2P-5.....88	JR-4073-10.....93	JR-56-5.....37	JR-9000-0014.....83	JR-C-NEU.5FPKB.....43	JR-S-40008.....70
JR-050RE-10.....48	JR-1110-02P-5.....64	JR-4074-10.....93	JR-57-5.....37	JR-9000-0520.....57	JR-C-NEU.5XFP.....43K	JR-S-40009.....73
JR-050WH-10.....48	JR-1110-05P-5.....88	JR-4075-10.....93	JR-58000-5.....23	JR-9000-0520B.....58	JR-CNFT.....103	JR-S-40104.....79
JR-050WL-10.....48	JR-1110-2P-5.....88	JR-408.....31	JR-58-5.....37	JR-9000-0520F.....57	JR-C-NL.15L-5.....43	JR-S-40106.....79
JR-050YL-10.....48	JR-1110-5P-5.....88	JR-4081-10.....93	JR-59-5.....38	JR-9000-0521.....57	JR-C-NL.15S-5.....43	JR-S-40108.....79
JR-051-10.....47	JR-1111-05P-5.....88	JR-4082-10.....93	JR-6029.....52	JR-9000-0521F.....57	JR-C-NL.20L-5.....43	JR-S-40200.....79
JR-060-5.....49	JR-1111-10P-5.....88	JR-4083-10.....93	JR-6030.....52	JR-9000-0522.....57	JR-C-NL.20S-5.....43	JR-S-40304.....79
JR-061.....32	JR-1111-2P-5.....88	JR-4084-10.....93	JR-6031.....52	JR-9000-0522F.....57	JR-C-NL.25L-5.....43	JR-S-40306.....79
JR-0611.....35	JR-1111-5P-5.....88	JR-4085-10.....93	JR-6032.....52	JR-9000-0522HF.....57	JR-C-NL.25S-5.....43	JR-S-40308.....79
JR-0611-SS05-3.....62	JR-1125-05P-5.....89	JR-409.....31	JR-6033.....52	JR-9000-0522HF.....57	JR-C-NL.30L-5.....43	JR-S-40404.....79
JR-0611-SS2-3.....62	JR-1125-10P-5.....89	JR-410.....31	JR-6034.....52	JR-9000-0525GC.....58	JR-C-NL.30S-5.....43	JR-S-40406.....79
JR-0611-TI05.....623	JR-1125-2P-5.....89	JR-4676-10.....57	JR-6039.....52	JR-9000-0526G.....58	JR-C-NL.35L-5.....43	JR-SLC-85-1.....95
JR-0611-TI2-3.....62	JR-1125-5P-5.....89	JR-4676-10TF.....57	JR-6040.....52	JR-9000-0528G.....58	JR-C-NL.35S-5.....43	JR-SLC-85-10.....95
JR-0612.....35	JR-1127-05P-5.....89	JR-4676-2.....57	JR-6041.....52	JR-9000-0530.....57	JR-C-NNFFPK.....43	JR-SLC-85-100.....95
JR-0617.....35	JR-1127-2P-5.....89	JR-4676-2.5TF.....57	JR-6042.....52	JR-9000-0530F.....57	JR-CU4LPK.....51	JR-SLC-85-1000.....95
JR-062.....35	JR-1128-5P-5.....89	JR-4676-5TF.....57	JR-6043.....52	JR-9000-0531.....57	JR-F-255-079-10PE-5.....86	JR-SLC-85-2.....95
JR-0622.....35	JR-1150-10P-5.....89	JR-4677-10.....57	JR-6044.....52	JR-9000-0531F.....57	JR-FPKBSS.5-10.....30	JR-SLC-85-20.....95
JR-0623.....35	JR-1151-10P-5.....89	JR-4677-10TF.....57	JR-60-5.....38	JR-9000-0532.....57	JR-FPKBSS1-10.....30	JR-SLC-85-200.....95
JR-0625.....35	JR-1FR1-5.....87	JR-4677-2.....57	JR-6120-50030.....84	JR-9000-0532F.....57	JR-FRK1.....103	JR-SLC-85-250.....95
JR-0626.....35	JR-1FR2-5.....87	JR-4677-2.5TF.....57	JR-6140.....17	JR-9000-0602.....60	JR-FRK2.....103	JR-SLC-85-3.....95
JR-062-C.....91	JR-201094BK-10.....49	JR-4677-5TF.....57	JR-6141-10.....17	JR-9000-0603.....60	JR-HKS3.....103	JR-SLC-85-300.....95
JR-064.....50	JR-201094WH-10.....49	JR-5-20003.....67	JR-65001NF.....91	JR-9000-0604.....60	JR-LZN1-5.....37	JR-SLC-85-4.....95
JR-0640.....51	JR-20116-10.....48	JR-5-20004.....67	JR-65002NF.....91	JR-9000-0604H.....60	JR-LZNF1PK-5.....27	JR-SLC-85-5.....95
JR-0641-SS05.....62	JR-20124-10.....48	JR-5-20006.....67	JR-65003NF.....91	JR-9000-0640.....60	JR-LZP1PK.....31	JR-SLC-85-500.....95
JR-0641-SS2.....62	JR-201532.....99	JR-5-20007.....67	JR-65005NF.....91	JR-9000-0641.....60	JR-MZNF1-5.....37	JR-SLC-86-100.....96
JR-0641-TI05.....62	JR-201536.....99	JR-5-20008.....67	JR-65006NF.....91	JR-9000-0642.....60	JR-MZNF1PK-5.....27	JR-SLC-86-1000.....96
JR-0641-TI2.....62	JR-201537.....99	JR-5-20009.....67	JR-65011.....92	JR-9000-0670.....34	JR-MZP1PK.....31	JR-SLC-86-200.....96
JR-065.....50	JR-201539.....99	JR-5003-5.....28	JR-65158.....92	JR-9001.....100	JR-MZP1PK.....31	JR-SLC-86-250.....96
JR-0650.....51	JR-201540.....47	JR-5004-5.....29	JR-660100.....55	JR-BPR1.....102	JR-MZP1PK.....31	JR-SLC-86-500.....96
JR-066.....32	JR-201540B.....99	JR-5005-5.....95	JR-660110.....55	JR-BPR-1KF.....102	JR-S-11001.....72	JR-SLC-86-500.....96
JR-067.....32	JR-201540L.....99	JR-5010N-5.....28	JR-660200.....55	JR-BPR2.....102	JR-S-11002.....72	JR-SLC-86-5.....96
JR-068.....50	JR-201541.....99	JR-55010-5.....23	JR-660210.....55	JR-BPR-2KF.....102	JR-S-11003.....72	JR-SLC-86-50.....96
JR-0680.....51	JR-201554.....99	JR-55011-5.....23	JR-660300.....55	JR-BPR3.....102	JR-S-11003W.....76	JR-SLC-86-1000.....96
JR-0691.....35	JR-201580BK-10.....49	JR-55012-5.....23	JR-660310.....55	JR-C360C.....45	JR-S-11005.....72	JR-SLC-86-250.....96
JR-070101-10.....54	JR-201580WH-10.....49	JR-55013-5.....23	JR-660320.....55	JR-C360CFS.....45	JR-S-11006.....72	JR-SLC-86-500.....96
JR-070111-10.....54	JR-201926-10.....47	JR-55014-5.....23	JR-66140.....91	JR-C360EPK.....44	JR-S-11011.....71	JR-SLR-111-77.....97
JR-070112-10.....54	JR-201928-10.....47	JR-55015-5.....23	JR-67140-1B.....92	JR-C360ET.....44	JR-S-11012.....71	JR-SLR-112-77.....97
JR-070113-10.....54	JR-201999.....79	JR-55016-12.....23	JR-67140-2B.....92	JR-C360NFFS.....45	JR-S-11013.....71	JR-SLR-113.....97
JR-070123-10.....54	JR-201999-10.....55	JR-55020-5.....26	JR-67-250-2A.....92	JR-C360NFPK.....44	JR-S-11052.....80	JR-SLR-113-77.....97
JR-070124-10.....54	JR-202118-10.....49	JR-55020-PVDF-5.....26	JR-67-250-4.....92	JR-C360NFS6.....45	JR-S-11101.....72	JR-SLR-114.....97
JR-070211-10.....54	JR-202119-10.....49	JR-55021-5.....26	JR-68181NF.....91	JR-C360PPK.....44	JR-S-11102.....72	JR-SLR-114-77.....97
JR-070212-10.....54	JR-202120-10.....49	JR-55022-5.....26	JR-68182NF.....91	JR-C360QTPK2.....44	JR-S-11103.....72	JR-SLR-115.....97
JR-070213-10.....54	JR-202121-10.....49	JR-55023-5.....26	JR-68183NF.....91	JR-C360QTPK4.....44	JR-S-11111.....70	JR-SLR-115-77.....97
JR-070224-10.....54	JR-202122-10.....49	JR-55024-5.....26	JR-68184NF.....91	JR-C360QTPK6.....44	JR-S-11112.....70	JR-SLR-116.....97
JR-070225-10.....54	JR-202123-10.....49	JR-55025-5.....26	JR-68185NF.....91	JR-C360QUPK2.....44	JR-S-11113.....70	JR-SLR-116-77.....97
JR-070226-10.....54	JR-202124-10.....49	JR-55031-5.....27	JR-68186NF.....91	JR-C360QUPK4.....44	JR-S-11201.....72	JR-SLR-117.....97
JR-070350-10.....83	JR-202125-10.....49	JR-5504-5.....26	JR-68230-02.....65	JR-C360QUPK6.....44	JR-S-11202.....72	JR-SLR-117-77.....97
JR-071123-10.....54	JR-202142-10.....49	JR-5505.....35	JR-68230-05.....65	JR-C360QXPk2.....44	JR-S-11203.....72	JR-SLR-118.....97
JR-071124-10.....54	JR-202143-10.....49	JR-55050-10.....30	JR-68230-2.....65	JR-C360QXPk4.....44	JR-S-11211.....70	JR-SLR-118-77.....97
JR-071323-10.....54	JR-202144-10.....49	JR-55051-10.....47	JR-68230-5.....65	JR-C360QXPk6.....44	JR-S-11212.....70	JR-SLR-2190.....95
JR-071324-10.....54	JR-202145-10.....49	JR-55060-10.....47	JR-68231-05.....65	JR-C360RU.5FS4.....45	JR-S-11213.....70	JR-SLR-2191.....95
JR-072350-10.....55	JR-202235.....99	JR-55061-10.....47	JR-68231-2.....65	JR-C360RU.5FS6.....45	JR-S-13001.....73	JR-SLR-2192.....95
JR-072450-10.....55	JR-2030.....34	JR-55070-10.....47	JR-68231-5.....65	JR-C360RU.5S62.....45	JR-S-13002.....73	JR-SLR-2193.....95
JR-073001.....79	JR-2032.....34	JR-55071-10.....47	JR-68242TI.....92	JR-C360RU.5S64.....45	JR-S-13003.....73	JR-SLR-2194.....95
JR-073210-10.....54	JR-2033.....34	JR-55072-10.....47	JR-68242TI2.....92	JR-C360RU.5S66.....45	JR-S-13011.....80	JR-SLR-2195.....95
JR-073220-10.....54	JR-2040.....34	JR-55073-10.....47	JR-68247.....92	JR-C360RU1FS6.....45	JR-S-14002.....73	JR-SLR-2196.....95
JR-073230-10.....54	JR-2042.....34	JR-5507-5.....26	JR-68252TI.....92	JR-C360RU1PK6.....44	JR-S-15001.....73	JR-SLR-2200.....95
JR-075012.....54	JR-2043.....34	JR-55080-10.....23	JR-68252TI2.....92	JR-C360RU1S66.....45	JR-S-15002.....73	JR-SLR-2201.....95
JR-075013.....54	JR-26501.....93	JR-55080-5.....23	JR-68253.....62	JR-C360UFS2.....45	JR-S-15003.....73	JR-SLR-2202.....95
JR-082.....41	JR-26502.....93	JR-55081-10.....23	JR-68256.....62	JR-C360UFS4.....45	JR-S-15011.....71	JR-SLR-2204.....95
JR-083-5.....41	JR-26503.....93	JR-55081-5.....23	JR-68257.....62	JR-C360UFS6.....45	JR-S-15012.....71	JR-SLR-2206.....95
JR-086.....41	JR-26504.....93	JR-55082-10.....23	JR-68257PE.....62	JR-C360UPK2.....44	JR-S-15013.....71	JR-SLR-2207.....95
JR-087-5.....41	JR-27305.....92	JR-55082-5.....23	JR-68258.....63	JR-C360UPK4.....44	JR-S-15052.....80	JR-SLR-2210.....95
JR-096.....41	JR-2FR1-5.....87	JR-55083-10.....23	JR-68262.....63	JR-C360UPK6.....44	JR-S-15103.....77	JR-SLR-2222.....95
JR-097-5.....41	JR-2FR1K-5.....87	JR-55083-5.....23	JR-68263.....63	JR-C360US62.....45	JR-S-15113.....77	JR-SLV-75-1.....95
JR-1030.....34	JR-2FR1KI-5.....87	JR-55084-10.....23	JR-68264.....63	JR-C360US64.....45	JR-S-15152.....81	JR-SLV-75-10.....95
JR-1032.....34	JR-2FR1TI-5.....87	JR-55084-5.....23	JR-68264PE.....63	JR-C360US66.....45	JR-S-15303.....78	JR-SLV-75-100.....95
JR-1033.....34	JR-2FR2-5.....87	JR-55085-10.....23	JR-69230-02.....64	JR-C5M1PK.....52	JR-S-15313.....78	JR-SLV-75-1000.....95
JR-1040.....34	JR-2FR2TI-5.....87	JR-55085-5.....23	JR-69230-05.....64	JR-C5M2PK.....52	JR-S-15352.....81	JR-SLV-75-2.....95
JR-1042.....34	JR-2FR4-5.....87	JR-55086-10.....23	JR-69230-2.....64	JR-C9M1PK.....52	JR-S-16003.....77	JR-SLV-75-20.....95
JR-1043.....34	JR-2FR4TI-5.....87	JR-55086-5.....23	JR-69230-5.....64	JR-C9M2PK.....52	JR-S-16013.....77	JR-SLV-75-250.....95
JR-1061.....32	JR-2FR6-5.....87	JR-55087-10.....23	JR-792.....101	JR-CBN.....32	JR-S-16052.....81	JR-SLV-75-3.....95
JR-1064.....50	JR-2FR6TI-5.....87	JR-55087-5.....23	JR-793.....101	JR-CBULPK.....50	JR-S-16103.....77	JR-SLV-75-4.....95

GENERAL REFERENCE



JR-SLV-75-595	JR-T-4036-M1.515	JR-T-5804-M1510	JR-T-6020-M1512	JR-T-6800-M1.515	JR-T-9602021	JR-TSS.505-M1019
JR-SLV-75-5095	JR-T-4036-M1015	JR-T-5804-M2510	JR-T-6020-M2512	JR-T-6800-M1015	JR-T-9602521	JR-TSS.505-M319
JR-SLV-75-50095	JR-T-4036-M1515	JR-T-5804-M310	JR-T-6020-M312	JR-T-6800-M1515	JR-T-9603021	JR-TSS.507-M1.519
JR-SLV-76-1096	JR-T-4036-M2515	JR-T-5804-M510	JR-T-6030-M1.512	JR-T-6800-M2515	JR-T-9603521	JR-TSS.507-M1019
JR-SLV-76-10096	JR-T-4036-M315	JR-T-5993-M1.59	JR-T-6030-M1012	JR-T-6800-M315	JR-T-9610521	JR-TSS.507-M319
JR-SLV-76-100096	JR-T-4036-M515	JR-T-5993-M109	JR-T-6030-M1512	JR-T-6800-M3.9915	JR-T-9610821	JR-TSS.510-M1.519
JR-SLV-76-2096	JR-T-4037-M1.515	JR-T-5993-M39	JR-T-6030-M2512	JR-T-6800-M515	JR-T-9611021	JR-TSS.510-M1019
JR-SLV-76-25096	JR-T-4037-M1015	JR-T-5998-00059	JR-T-6030-M312	JR-T-6801-M1.515	JR-T-9611321	JR-TSS.510-M319
JR-SLV-76-596	JR-T-4037-M1515	JR-T-5998C-M1.510	JR-T-6040-M1.512	JR-T-6801-M1015	JR-T-9611521	JR-TSS.520-M1.519
JR-SLV-76-5096	JR-T-4037-M2515	JR-T-5998C-M1010	JR-T-6040-M1012	JR-T-6801-M1515	JR-T-9612021	JR-TSS.520-M1019
JR-SLV-76-50096	JR-T-4037-M315	JR-T-5998C-M1510	JR-T-6040-M1512	JR-T-6801-M2515	JR-T-9612521	JR-TSS.520-M319
JR-SWH4103	JR-T-4037-M515	JR-T-5998C-M2510	JR-T-6040-M2512	JR-T-6801-M315	JR-T-9613021	JR-TSS105-M1.519
JR-T-079-M1.513	JR-T-4039-M1.515	JR-T-5998C-M310	JR-T-6040-M312	JR-T-6802-M1.516	JR-T-9613521	JR-TSS105-M1019
JR-T-079-M1013	JR-T-4039-M1015	JR-T-5998C-M510	JR-T-6105-M1.516	JR-T-6802-M1016	JR-T-9614521	JR-TSS105-M319
JR-T-079-M1513	JR-T-4039-M315	JR-T-5998-M1.59	JR-T-6105-M1016	JR-T-6802-M1516	JR-T-9620521	JR-TSS110-M1.519
JR-T-079-M2513	JR-T-404115	JR-T-5998-M109	JR-T-6105-M1516	JR-T-6802-M2516	JR-T-9620821	JR-TSS110-M1019
JR-T-079-M313	JR-T-404215	JR-T-5998-M39	JR-T-6105-M2516	JR-T-6802-M316	JR-T-9621021	JR-TSS110-M319
JR-T-080-M1.513	JR-T-404315	JR-T-5999-M1.510	JR-T-6105-M316	JR-T-6803-M1.516	JR-T-9621321	JR-TSS115-M1.519
JR-T-080-M1013	JR-T-405015	JR-T-5999-M1010	JR-T-6130-M1017	JR-T-6803-M1016	JR-T-9621521	JR-TSS115-M1019
JR-T-080-M1513	JR-T-4183C-M1014	JR-T-5999-M1510	JR-T-6130-M317	JR-T-6803-M1516	JR-T-9622021	JR-TSS115-M319
JR-T-080-M2513	JR-T-4183C-M2514	JR-T-5999-M2510	JR-T-620159	JR-T-6803-M2516	JR-T-9622521	JR-TSS120-M1.519
JR-T-080-M313	JR-T-4183C-M314	JR-T-5999-M310	JR-T-6210-M1.516	JR-T-6803-M316	JR-T-9623021	JR-TSS120-M1019
JR-T-082-M1.513	JR-T-4183-M1.515	JR-T-5999-M510	JR-T-6210-M1016	JR-T-6804-M1.516	JR-T-9623521	JR-TSS120-M319
JR-T-082-M1013	JR-T-4183-M1015	JR-T-6000-M1.510	JR-T-6210-M1516	JR-T-6804-M1016	JR-T-9630521	JR-TSS130-M1.519
JR-T-082-M1513	JR-T-4183-M1515	JR-T-6000-M1010	JR-T-6210-M2516	JR-T-6804-M1516	JR-T-9630821	JR-TSS130-M1019
JR-T-082-M2513	JR-T-4183-M2515	JR-T-6000-M1510	JR-T-6210-M316	JR-T-6804-M2516	JR-T-9631021	JR-TSS130-M319
JR-T-082-M313	JR-T-4183-M315	JR-T-6000-M2510	JR-T-623-0319	JR-T-6804-M316	JR-T-9631321	JR-TSS140-M1.519
JR-T-083-M1.513	JR-T-4183-M515	JR-T-6000-M310	JR-T-623-0619	JR-T-6805-M1.515	JR-T-9631521	JR-TSS140-M1019
JR-T-083-M1013	JR-5580-529	JR-T-6000-M510	JR-T-625-03-M1.519	JR-T-6805-M1015	JR-T-9632021	JR-TSS140-M319
JR-T-083-M1513	JR-T-5602-M112	JR-T-6001-M1.510	JR-T-625-03-M1019	JR-T-6805-M1515	JR-T-9632521	JR-TSS230-M1.519
JR-T-083-M2513	JR-T-5602-M312	JR-T-6001-M1010	JR-T-625-03-M319	JR-T-6805-M2515	JR-T-9633021	JR-TSS230-M1019
JR-T-083-M313	JR-T-5603-M112	JR-T-6001-M1510	JR-T-625-04-M1.519	JR-T-6805-M315	JR-T-9633521	JR-TSS230-M319
JR-T-084-M1.513	JR-T-5603-M312	JR-T-6001-M2510	JR-T-625-04-M1019	JR-T-6805-M515	JR-T-9700520	JR-TSS240-M1.519
JR-T-084-M1013	JR-T-5604-M112	JR-T-6001-M310	JR-T-625-04-M319	JR-T-6806-M1.516	JR-T-9701020	JR-TSS240-M1019
JR-T-084-M1513	JR-T-5604-M312	JR-T-6001-M510	JR-T-625-05-M1.519	JR-T-6806-M1016	JR-T-9701220	JR-TSS240-M319
JR-T-084-M2513	JR-T-5605-M112	JR-T-6001-M1010	JR-T-625-05-M1019	JR-T-6806-M1516	JR-T-9701320	JR-TSS260-M1.519
JR-T-084-M313	JR-T-5605-M312	JR-T-6002-M1010	JR-T-625-05-M319	JR-T-6806-M2516	JR-T-9701520	JR-TSS260-M319
JR-T-085-M1.513	JR-T-5606-M112	JR-T-6002-M1510	JR-T-625-10-M1.519	JR-T-6806-M316	JR-T-9702020	JR-TSS260-M1019
JR-T-085-M1013	JR-T-5606-M312	JR-T-6002-M2510	JR-T-625-10-M1019	JR-T-6807-M1.515	JR-T-9702520	JR-TSS267-M1.519
JR-T-085-M1513	JR-T-5607-M112	JR-T-6002-M310	JR-T-625-10-M319	JR-T-6807-M1015	JR-T-9703020	JR-TSS267-M1019
JR-T-085-M2513	JR-T-5607-M312	JR-T-6002-M510	JR-T-625-20-M1.519	JR-T-6807-M1515	JR-T-9703220	JR-TSS267-M319
JR-T-085-M313	JR-T-5608-M112	JR-T-6003-M1.510	JR-T-625-20-M1019	JR-T-6807-M2515	JR-T-9703320	JR-TSS285-M1.519
JR-T-086-M1.513	JR-T-5608-M312	JR-T-6003-M1010	JR-T-625-20-M319	JR-T-6807-M315	JR-T-9703520	JR-TSS285-M1019
JR-T-086-M1013	JR-T-5610-M112	JR-T-6003-M1510	JR-T-625-30-M1.519	JR-T-6807-M515	JR-T-9704020	JR-TSS285-M319
JR-T-086-M1513	JR-T-5610-M312	JR-T-6003-M2510	JR-T-625-30-M1019	JR-T-6808-M1014	JR-T-9704520	JR-ZBU1CFPK32
JR-T-086-M2513	JR-T-5620-M112	JR-T-6003-M310	JR-T-625-30-M319	JR-T-6808-M2514	JR-T-9705520	JR-ZBU1FFPK32
JR-T-086-M313	JR-T-5620-M312	JR-T-6003-M510	JR-T-625-40-M1.519	JR-T-6808-M314	JR-T-9705720	JR-ZBU1MFPK32
JR-T-087-M113	JR-T-5664-M112	JR-T-6003-M1010	JR-T-625-40-M1019	JR-T-680916	JR-T-9705820	JR-ZC.539
JR-T-087-M313	JR-T-5664-M312	JR-T-6003-M1510	JR-T-625-40-M319	JR-T-681015	JR-T-9706020	JR-ZC.5FPK31
JR-T-088-M113	JR-T-5702-M110	JR-T-6003-M2510	JR-T-626-00-M1.519	JR-T-6811-M1014	JR-T-9706520	JR-ZC139
JR-T-088-M313	JR-T-5702-M1.510	JR-T-6003-M2510	JR-T-626-00-M1019	JR-T-6811-M2514	JR-T-9707520	JR-ZC1PK31
JR-T-089-M1.513	JR-T-5702-M310	JR-T-6003-M310	JR-T-626-00-M319	JR-T-6811-M314	JR-T-9708020	JR-ZC239
JR-T-089-M1013	JR-T-5703-M110	JR-T-6003-M510	JR-T-628-0019	JR-T-6812-M1.516	JR-T-9708220	JR-ZF.5PK33
JR-T-089-M1513	JR-T-5703-M1.510	JR-T-6003-M1010	JR-T-6310-M1.516	JR-T-6812-M1016	JR-T-9708320	JR-ZF.5PK-528
JR-T-089-M2513	JR-T-5703-M310	JR-T-6003-M1510	JR-T-6310-M1016	JR-T-6812-M1516	JR-T-9708520	JR-ZF.5S6-538
JR-T-089-M313	JR-T-5704-M110	JR-T-6003-M1010	JR-T-6310-M1516	JR-T-6812-M2516	JR-T-9709020	JR-ZF156-538
JR-T-090-M113	JR-T-5704-M1.510	JR-T-6003-M2510	JR-T-6310-M2516	JR-T-6812-M316	JR-T-9709520	JR-ZF2PK-528
JR-T-090-M313	JR-T-5704-M310	JR-T-6003-M310	JR-T-6310-M316	JR-T-6813-M1.516	JR-T-9710020	JR-ZF2S6-538
JR-T-4001-M1.513	JR-T-5705-M110	JR-T-6003-M510	JR-T-6320-M1.516	JR-T-6813-M1016	JR-T-9710220	JR-ZGF.5PK43
JR-T-4001-M1013	JR-T-5705-M1.510	JR-T-6004-M109	JR-T-6320-M1016	JR-T-6813-M1516	JR-T-9710320	JR-ZGF1PK43
JR-T-4001-M1513	JR-T-5705-M310	JR-T-6004-M39	JR-T-6320-M1516	JR-T-6813-M2516	JR-T-9710520	JR-ZN.537
JR-T-4001-M2513	JR-T-5706-M1.59	JR-T-6004-M109	JR-T-6320-M2516	JR-T-6813-M316	JR-T-9711020	JR-ZN.5FPK33
JR-T-4001-M313	JR-T-5706-M109	JR-T-6004-M39	JR-T-6320-M316	JR-T-6835-M1.516	JR-TD-5804-M1.511	JR-ZN.5FPK-528
JR-T-4002-M1.513	JR-T-5706-M39	JR-T-6004-M109	JR-T-6605-M116	JR-T-6835-M1016	JR-TD-5804-M1011	JR-ZN1-537
JR-T-4002-M1013	JR-T-5707-M110	JR-T-6004-M39	JR-T-6605-M1016	JR-T-6835-M1516	JR-TD-5804-M1511	JR-ZN2-537
JR-T-4002-M1513	JR-T-5707-M1.510	JR-T-60069	JR-T-6605-M316	JR-T-6835-M2516	JR-TD-5804-M2511	JR-ZN2PK-528
JR-T-4002-M2513	JR-T-5707-M310	JR-T-6007-M1.512	JR-T-6606-M116	JR-T-6835-M316	JR-TD-5804-M311	JR-ZNF1FPK-527
JR-T-4002-M313	JR-T-5708-M110	JR-T-6007-M1012	JR-T-6606-M1016	JR-T-684016	JR-TD-6007-M1.511	JR-ZNF1PK-527
JR-T-4003-M1.513	JR-T-5708-M1.510	JR-T-6007-M1512	JR-T-6606-M316	JR-T-684116	JR-TD-6007-M1011	JR-ZNF1PK-F-527
JR-T-4003-M1013	JR-T-5708-M310	JR-T-6007-M2512	JR-T-6607-M116	JR-T-686016	JR-TD-6007-M1511	JR-ZNFT103
JR-T-4003-M1513	JR-T-5710-M110	JR-T-6007-M312	JR-T-6607-M1016	JR-T-7360-02518	JR-TD-6007-M2511	JR-ZP.538
JR-T-4003-M2513	JR-T-5710-M1.510	JR-T-6008-M1.512	JR-T-6607-M316	JR-T-7360-05018	JR-TD-6007-M311	JR-ZP.5FPK31
JR-T-4003-M313	JR-T-5710-M310	JR-T-6008-M1012	JR-T-6610-M116	JR-T-7360-07518	JR-TD-6008-M1.511	JR-ZP138
JR-T-400513	JR-T-5720-M110	JR-T-6008-M1512	JR-T-6610-M1016	JR-T-7360-10018	JR-TD-6008-M1011	JR-ZP1FPK31
JR-T-4007-M1.513	JR-T-5720-M1.510	JR-T-6008-M2512	JR-T-6610-M316	JR-T-7360-15018	JR-TD-6008-M1511	JR-ZP238
JR-T-4007-M1013	JR-T-5720-M310	JR-T-6008-M312	JR-T-6615-M116	JR-T-7360-18018	JR-TD-6008-M2511	JR-ZR1S6-596
JR-T-4007-M1513	JR-T-5764-M110	JR-T-6009-M1.512	JR-T-6615-M1016	JR-T-9105020	JR-TD-6008-M311	JR-ZRU2140
JR-T-4007-M2513	JR-T-5764-M1.510	JR-T-6009-M1012	JR-T-6615-M316	JR-T-9110020	JR-TD-6009-M1.511	JR-ZRU21FPK33
JR-T-4007-M313	JR-T-5764-M310	JR-T-6009-M1512	JR-T-6620-M116	JR-T-9113020	JR-TD-6009-M1011	JR-ZT139
JR-T-400913	JR-T-5802-M1.510	JR-T-6009-M2512	JR-T-6620-M1016	JR-T-9118020	JR-TD-6009-M1511	JR-ZT1C39
JR-T-4011C-M1014	JR-T-5802-M1010	JR-T-6009-M312	JR-T-6620-M316	JR-T-9120020	JR-TD-6009-M2511	JR-ZT1M39
JR-T-4011C-M2514	JR-T-5802-M1510	JR-T-6010-M1.512	JR-T-665016	JR-T-9130020	JR-TD-6009-M311	JR-ZU1CS640
JR-T-4011C-M314	JR-T-5802-M2510	JR-T-6010-M1012	JR-T-6702-M1.516	JR-T-9205020	JR-TD-6010-M1.511	JR-ZU1MS640
JR-T-4011-M1.515	JR-T-5802-M310	JR-T-6010-M1512	JR-T-6702-M1016	JR-T-9210020	JR-TD-6010-M1011	JR-ZU1S640
JR-T-4011-M1015	JR-T-5802-M510	JR-T-6010-M2512	JR-T-6702-M1516	JR-T-9213020	JR-TD-6010-M1511	JR-ZU1XCS640
JR-T-4011-M1515	JR-T-5803-M1.510	JR-T-6010-M312	JR-T-6702-M2516	JR-T-9218020	JR-TD-6010-M2511	JR-ZUFLPK35
JR-T-4011-M2515	JR-T-5803-M1010	JR-T-6011-M1.512	JR-T-6702-M316	JR-T-9220020	JR-TD-6010-M311	JR-ZX139
JR-T-4011-M315	JR-T-5803-M1510	JR-T-6011-M1012	JR-T-6797-M116	JR-T-9230020	JR-TD-6011-M1.511	JR-ZX1C39
JR-T-4011-M515	JR-T-5803-M2510	JR-T-6011-M1512	JR-T-6797-M1016	JR-T-9600521	JR-TD-6011-M1011	JR-ZX1M39
JR-T-403699	JR-T-5803-M310	JR-T-6011-M2512	JR-T-6797-M316	JR-T-9600821	JR-TD-6011-M1511	
JR-T-4036C-M1014	JR-T-5803-M510	JR-T-6011-M312	JR-T-6798-M116	JR-T-960		



GENERAL REFERENCE

A

Adapters
 High pressure PEEK 35
 Low pressure polypropylene 54
 Air inlet valve..... 67
 Air outlet filter..... 67

B

Backpressure regulators 102
 Barbed hose adapter
 for 1/8" ID tubing..... 75
 Bottles, safety-coated glass 84
 Bulkhead unions, PEEK
 High pressure 32
 Low pressure..... 50
 Bushing for high pressure
 1/4-28 connection..... 31

C

Caps
 Nanovolume® 360 µm.... 44-45
 PEEK..... 31
 Stainless..... 39
 Carbon dioxide filter..... 85
 ChromBox kit..... 105
 Clean-Cut tubing cutter..... 100
 Color-It fingertight adapters 23
 Color-Sleeve
 fingertight adapters..... 23
 Column couplers 93
 Column end plugs
 Color-coded 93
 Logotype 93
 Column packing kit..... 92
 Columns, PEEK
 2.1 mm 91
 4.0 mm 91
 Crosses
 Nanovolume® 44
 PEEK
 High pressure..... 34
 Low pressure 52
 Stainless 39
 Cutting wheel SS tubing cutter 101

E

ETFE tubing 13
 Easy-Flange kit 99
 Easy-Flange combi kit 99
 Eco cap 83
 Eco cap kit 83
 Economy Last Drop
 mobile phase filters 57
 Elbows for PEEK tubing 100
 Exhaust filter 68

F

FEP tubing 16
 Ferrule removal kits..... 103
 Ferrules
 High pressure
 Collapsible 43
 Nanovolume® 43
 PEEK
 Collapsible 43
 Double-ended..... 29
 Single 28
 UHPLC 28

F, continued

Ferrules, continued
 High pressure, continued
 Stainless
 Metric..... 41
 Rheodyne 38
 Valco 38
 Low pressure
 Collapsible..... 47
 Inverted 47
 File 101
 Filters
 UHPLC stainless
 In-line filter..... 65
 Precolumn filter 64
 High pressure PEEK
 In-line filter kit..... 62
 Precolumn filter kit ... 63
 Sure-Guard..... 62
 Low pressure
 Economy Last Drop 57
 In-line 56
 Last Drop 57
 Last Drop glass 58
 Mobile phase filters ... 57-59
 No-Met biocompatible... 59
 Safety
 Air outlet filter 67
 Carbon dioxide filter 85
 Humidity filter 85
 Filter/spargers
 Last Drop 60
 Stainless steel 61
 Fingertight adapters
 Color-It 23
 Color-Sleeve 23
 Fingertight one-piece column
 couplers 93
 Flanged nuts
 Fingertight color-coded 49
 Hex-head nuts 47
 Flangeless nuts
 Fingertight color-coded 48
 Fingertight PEEK 48
 Hex-head nuts 47
 Frits
 for PEEK filter kits..... 63
 for stainless in-line filter 65
 for stainless pre-column filter 64
 PEEK-encased
 Stainless..... 89
 Titanium..... 89
 Polyethylene..... 89
 Unidense
 Stainless..... 87
 Titanium..... 87
 Polyethylene..... 86
 Fused silica capillaries 18

G

Guard columns,
 in-line biocompatible 92
 Guillotine tubing cutter..... 100

H

Hex key set..... 103
 Humidity filter..... 85

I

Impermeable polymeric tubing 17
 In-line biocompatible
 guard column 92
 In-line filter cartridges 56
 In-line filter, stainless steel 65
 In-line filter kit
 PEEK..... 62
 Sure-guard 62

K

Kits
 Chrombox kit 9105
 Easy-Flange kit 99
 Easy-Flange combi kit 99
 PEEK starter kit 104
 Stainless steel starter kit ... 104

L

Last Drop biocompatible glass
 mobile phase filters 58
 Last Drop filter/sparger 60
 Last Drop mobile phase filters... 57
 Liners for 1/32" Nanovolume®
 fittings..... 43
 Loops
 PEEK..... 94-95
 Stainless steel..... 96-97

M

Manifolds, low pressure PEEK ... 52
 Micro valves for GC and LC..... 55
 Mixing tees
 Biocompatible high pressure 34
 Low pressure..... 53
 Mobile phase filters
 Biocompatible glass..... 58
 Economy Last Drop 57
 Last Drop 57
 No-Met biocompatible 59
 Multi caps 80-82

N

Nanovolume® fittings
 for 1/32" tubing 43
 for 360 µm tubing 44-45
 No-Met biocompatible
 mobile phase filters 59
 Nuts
 High pressure
 PPS..... 31
 PEEK
 for double ferrules... 29
 for single ferrules 28
 Stainless
 Rheodyne compatible 37
 Valco..... 37
 Low pressure
 Flanged
 Fingertight
 color-coded..... 49
 Hex-head 47
 Flangeless
 Fingertight
 color-coded..... 48
 Fingertight PEEK..... 48
 Hex-head 47
 Nanovolume®
 1/32" 43
 360 micron 44-45

O

One-piece fittings
 Column couplers..... 93
 Nanovolume® nut-ferrule. 43-45
 No-twist PEEK..... 27
 PPS hex-head 25
 PEEK fingertight
 Color-coded 26
 Natural 26
 HT™ 27
 PEEK hex-head
 5000 psi 25
 UHPLC..... 25
 HT™ 25
 PVDF 26

P

PEEK columns 91
 PEEK starter kit 104
 PEEK tubing
 Dual layer color-coded 11
 Natural 9
 Solid color-coded 12
 Striped color-coded 10
 PEEK tubing elbows 100
 PFA tubing 13
 PTFE tubing
 Natural color..... 15
 Solid color-coded 14
 Packing kits
 for PEEK columns..... 92
 for guard columns..... 92
 Peristaltic tubing adapter set... 53
 Plier type SS tubing cutter 101
 Plugs
 High pressure
 PEEK..... 31
 Stainless..... 38
 Low pressure
 Polypropylene 55
 Precolumn filter kit, PEEK 63
 Precolumn filter, stainless..... 64

R

Reducing unions
 Nanovolume®..... 43-45
 PEEK, high pressure 33
 PEEK, low pressure
 Imperial 51
 Imperial to metric..... 51
 Stainless
 Imperial 40
 Imperial to metric..... 41

S

Safety
 Air inlet valves 67
 Air outlet filters 67
 Exhaust filters 68-69
 Caps..... 70-71
 Cap kit..... 70
 Carbon dioxide filter 85
 Humidity filter 85
 Safety-coated glass bottles 84
 Sample loops
 PEEK..... 94-95
 Stainless steel..... 96-97
 SolviFlex coiled tubing..... 84
 Stainless steel in-line filter 65
 Stainless steel mobile phase filter/
 helium sparger..... 61

**S, continued**

Stainless steel starter kit	104
Stainless steel tubing	
Pre-cut	20
Pre-cut, flexible	21
Bulk, premium grade	19
Bulk, standard grade	19
Stainless steel tubing cutters	
Cutting wheel type	101
Plier type	101
Starter kits	
Chrombox kit	105
PEEK starter kit	104
Stainless steel starter kit	104
Sure-Guard in-line filter kit	62

T

Tees	
Biocompatible mixing	34
Nanovolume®	44
PEEK	
High pressure	
Standard	34
Mixing	34
Low pressure	46
Standard	52
Mixing	53
Stainless	39

T, continued

Thermo-formed	
polymeric tubing	17
Tightening tool	
for PEEK fittings	103
Tubing	
ETFE	13
FEP	16
Impermeable	
polymeric tubing	17
PEEK	
Dual layer color-coded ...	11
Natural	9
Solid color-coded	12
Striped color-coded	10
PFA	13
PTFE	
Natural color	15
Solid color-coded	14
Stainless	
Pre-cut	20
Pre-cut, flexible	21
Bulk, premium grade	19
Bulk, standard grade	19
Thermo-formed	
polymeric tubing	17
Tubing clip	100
Tubing elbows	100

T, continued

Tubing cutters	
Clean-Cut (for polymers) ...	100
Cutting wheel type	
(for stainless)	101
Guillotine type	
(for polymers)	100
Plier type (for stainless)	101
Tweezer	103

U

UHPLC	
Filters	
Stainless in-line filter	63
Stainless precolumn	
filter	64
PEEK	
Ferrules	28
HT™ one-piece hex-head	
fittings	25
Stainless steel	
Caps	39
Crosses	39
Ferrules	38
Nuts	37
Plugs	38
Reducing unions	40-41
Tees	39
Unions	40

U, continued

Unidense frits	86-87
Unions	
Body only, for	
low-pressure flanged	49
Bulkhead ... <i>see Bulkhead unions</i>	
Nanovolume®	43-45
PEEK	
High pressure	32
Low pressure	50
Reducing ... <i>see Reducing unions</i>	
Stainless	40

V

VICI caps	72-75
VICI cap kit	72, 74
ValvTool	102

W

Washers	
for flanged connections	47
Waste caps	76-79
Wrenches	
Open end	103
ValvTool	103



- Valco valves
- Cheminert valves
- Actuators
- Valco fittings
- Cheminert fittings
- Tubing
- Flow, pressure, and on/off devices
- Dynacal® permeation devices
- Instrumentation
- GC columns
- GC purifiers

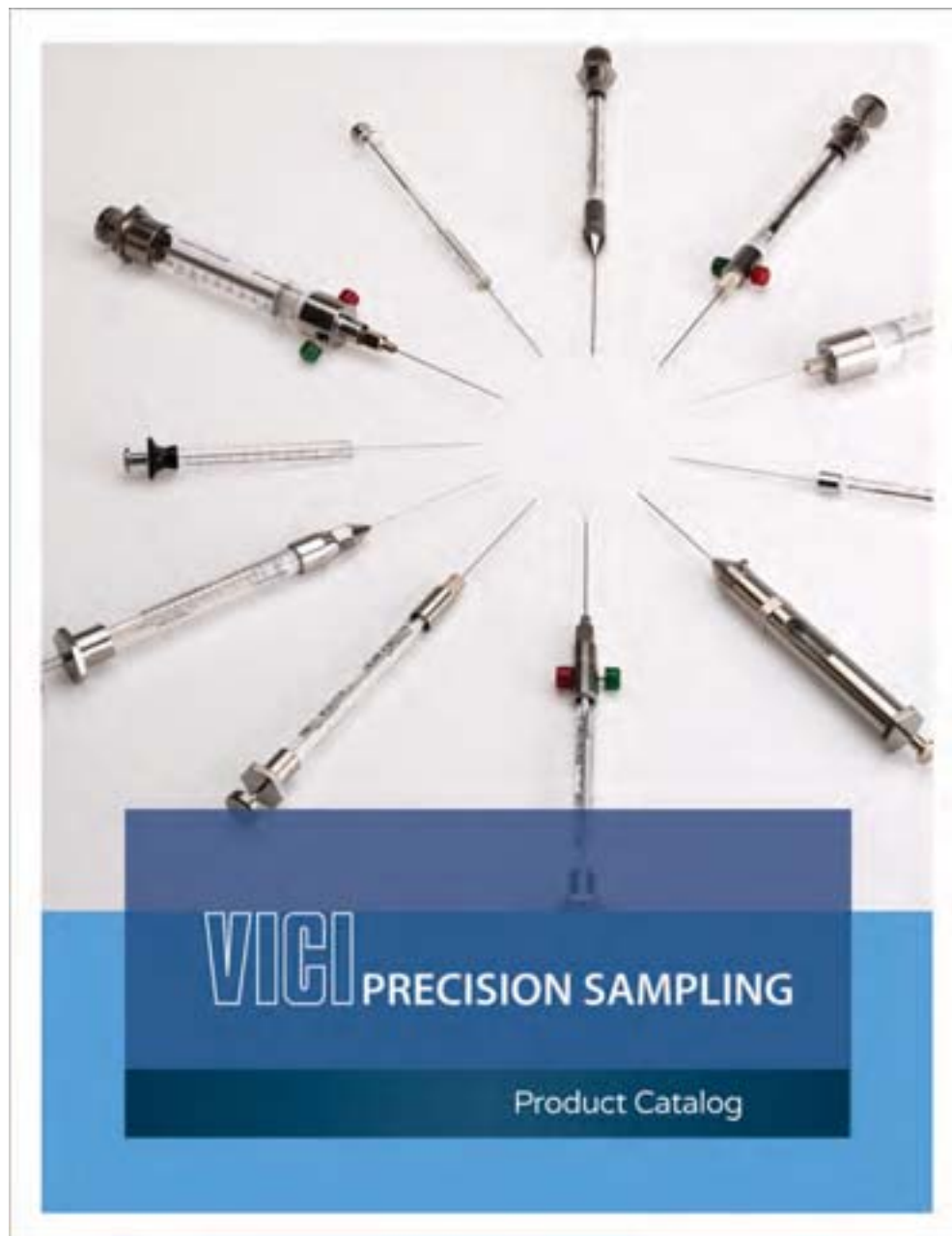

- Gas tight syringes
- HPLC injection syringes
- Magnum syringes up to 500 mL
- Syringes for sampling from gas cylinders
- Mininert™ – Valves for vials
- Customized probes and shaped tubing



GENERAL REFERENCE

Our sales personnel will work with you by email, phone, or fax to determine the best products for your specifications.

Our Schenkon, Switzerland, Brockville, Ontario, and Baton Rouge, Louisiana offices serve different regions of the world.

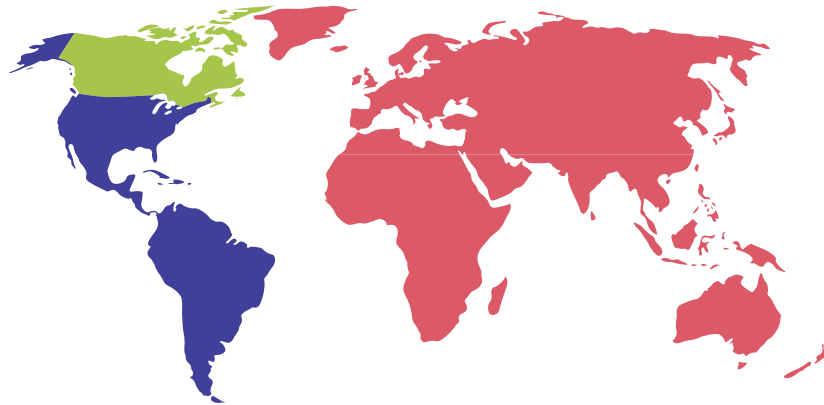

EUROPE, MIDDLE EAST, ASIA, AFRICA, AUSTRALIA, AND OTHER COUNTRIES

VICI AG INTERNATIONAL

Sales

- Phone: Int + 41·41·925-6200
- Fax: Int + 41·41·925-6201
- Email: order@vici.ch

Technical/Service

- Phone: Int + 41·41·925-6200
- Fax: Int + 41·41·925-6201
- Email: support@vici.ch

Parkstrasse 2
CH-6214 Schenkon / Switzerland
info@vici.ch

EXW shipping point, our factory,
Schenkon, Switzerland.

We accept:



NORTH, SOUTH, AND CENTRAL AMERICA (EXCEPT CANADA)

VICI PRECISION SAMPLING

Sales

- Toll-free: 800-828-1653
- Phone: 225-927-1128
- Fax: 225-923-1331
- Email: precsamp@vici.com

Technical/Service

- Phone: 225-927-1128
- Fax: 225-923-1331
- Email: precsamp@vici.com

P.O. Box 15886
Baton Rouge, Louisiana / USA
precsamp@vici.com

EXW shipping point, our factory,
Schenkon, Switzerland.

We accept:



CANADA

VICI VALCO INSTRUMENTS CANADA

Sales

- Toll-free: 866-297-2626
- Phone: 613-342-2600
- Fax: 613-342-0111
- Email: canada@vici.com

Technical/Service

- Phone: 613-342-2600
- Fax: 613-342-0111
- Email: canada@vici.com

26 Water Street East
Brockville, Ontario / Canada K6V 1A1
canada@vici.com

F.O.B. shipping point, our factory,
Brockville, Canada.

We accept:



Conditions of Sale

There is no minimum order.
Terms are net 30 days.
Prices subject to change without
notice.

Notice

VICI reserves the right to correct errors and change prices, designs, or specifications without notice or liability. The information in this catalog is correct to the best of our knowledge but is not guaranteed to be so. VICI assumes no responsibility with respect thereto.

Repairs

For repair return authorization or information about factory refurbishments, contact our Service Department.

Returns

No returns will be accepted more than 90 days after shipment for any reason. Before 90 days, no returns will be accepted without prior authorization. If it is necessary to return material to us, please contact our Sales Department for a return authorization number and forwarding instructions. Inspect shipments upon receipt and report

Technical Service

Our capable staff is waiting to assist you with your technical questions and application needs.

shortages and incorrect or damaged material to us immediately.

Important! Damaged shipments must remain with the original packaging for freight company inspection.

Returned material will be subject to a restocking charge of 20% for catalog items. Special orders cannot be returned unless defective.

AUSTRALIA

Chromalytic Technology P/L
 Phone: +61 3 9762 2034
 Email: sales@chromtech.net.au
 Web: www.chromtech.net.au
 www.chromalytic.net.au

BELGIUM

ACHROM nv/sa
 Phone: +32 9 3800647
 Fax: +32 9 3860866
 Email: achrom@achrom.be
 Web: www.achrom.be

CANADA

VICI Valco Instruments Canada Corp.
 Phone: +1 613 342 2600
 Toll free: +1 866 297 2626
 Fax: +1 613 342 0111
 Email: canada@vici.com
 Web: www.vici.com

CHINA

J & J Industries
 Phone: +86 10 65888666
 Fax: +86 10 65886577
 Email: sales@jjindustries.com.cn
 Web: www.jjindustries.com.cn

CZECH REPUBLIC

Chromservis s.r.o.
 Phone: +420 274 021 211
 Email: prodej@chromservis.eu
 Web: www.chromservis.eu

DENMARK

Mikrolab A/S
 Phone: +45 86 29 61 11
 Email: ml@mikrolab.dk
 Web: www.mikrolab.dk

FINLAND

Norlab Oy
 Phone: +358 9 8545 510
 Email: norlab@norlab.com
 Web: www.norlab.com

FRANCE

Interchim SA
 Phone: +33 4 70 03 88 55
 Fax: +33 4 70 03 82 60
 Email: interchrom@interchim.com
 Web: www.interchim.com

GERMANY

Macherey-Nagel GmbH & Co. KG
 Phone: +49 2421 9690
 Fax: +49 2421 969 199
 Email: sales-de@mn-net.com
 Web: www.mn-net.com

GREECE

N. Asteriadis S.A.
 Phone: +30 210 823 53 83
 Fax: +30 210 823 95 67
 Email: sales@asteriadis.gr
 Web: www.asteriadis.gr

HUNGARY

Novo-Lab Ltd.
 Phone: +36 1 347 0404
 Fax: +36 280 2100
 Email: info@novolab.hu
 Web: www.novolab.hu

INDIA

Unichrome Associates
 Phone: +91-98-21383939
 Email: info@unichromeassociates.com
 Web: www.unichromeassociates.com

IRELAND

Carl Stuart Ltd.
 Phone: +353 1 452 34 32
 Fax: +353 1 452 39 67
 Email: info@carlstuart.com
 Web: www.carlstuart.com

ISRAEL

Ophir Analytical LTD
 Phone: +972 3 9022277
 Fax: +972 3 9022488
 Email: ophir-ana@bezeqint.net
 Web: www.ophiranalytical.com

ITALY

C.P.S. Analitica S.r.l.
 Email: cps@cps.it
 Web: www.cps.it
Milano
 Phone: +39 02 895 4201
 Fax: +39 02 895 42022

Roma

Phone: +39 06 4742102
 Fax: +39 06 4742108

Labservice Analytica S.r.l.
 Phone: +39 051 732351
 Fax: +39 051 732759
 Email: info@labservice.it
 Web: www.labservice.it

JAPAN

GL Sciences Inc.
 Phone: +81 3 5323 6620
 Fax: +81 3 5323 6621
 Email: world@gls.co.jp
 Web: www.gls.co.jp

SOUTH-KOREA

Young-Wha Scientific Co., Ltd.
 Phone: +82 2 2140 5400
 Fax: +82 2 2140 5405
 Email: dhlee3@youngwha.com
 Web: www.youngwha.com

MALAYSIA

Scientific Trends (M) SDN. BHD
 Phone: +60 3 7877 1884
 Fax: +60 3 7877 1785
 +60 3 7865 665
 Email: lip@scientifictrends.com.my

NETHERLANDS

Da Vinci Laboratory Solutions B.V.
 Phone: +31 10 258 18 70
 Email: supplies@davinci-ls.com
 Web: www.davinci-ls.com

NORWAY

Teknolab AS
 Phone: +47 66 81 34 70
 Fax: +47 66 81 34 71
 Email: mail@teknolab.no
 Web: www.teknolab.no

PORTUGAL

STV
 Phone: +351 219 563 007
 Fax: +351 219 562 997
 Email: geral@stv.pt

RUSSIA

Fizlabpribor Ltd.
 Phone: +7 495 740 5406
 Fax: +7 495 988 8725
 Email: info@fizlabpribor.ru
 Web: www.fizlabpribor.ru

SINGAPORE

Nareen Technologies Pte Ltd.
 Phone: +65 6763 1196
 Fax: +65 6763 5576
 Email: enquiry@nareen.com.sg
 Web: www.nareen.com

SLOVENIJA

Kemomed d.o.o.
 Phone: +386 420 150 50
 Fax: +386 420 150 55
 Email: info@kemomed.si
 Web: www.kemomed.si

SOUTH AFRICA

Scientific Supply Services
 Phone: +27 11 476 8065
 Fax: +27 11 478 3489
 Email: ssscc@netactive.co.za
 Web: www.ssscc.co.za

SPAIN

Symta, S.L.L.
 Phone: +34 915 002 060
 Fax: +34 915 000 045
 Email: info@symta.com
 Web: www.symta.com

SWEDEN

Scantec Nordic AB
 Phone: +46 31 336 90 00
 Email: info@scantecnordic.se
 Web: www.scantecnordic.se

SWITZERLAND

BGB Analytik AG
 Phone: +41 61 991 00 46
 Fax: +41 61 991 00 25
 Email: sales@bgb-analytik.ch
 Web: bgb-analytik.ch

TAIWAN

Vercotech Inc.
 Phone: +886-2-2657-8289
 Fax: +886-2-2657-8389
 Email: chester.yang@vercopak.com.tw
 Web: www.vercopak.com.tw

THAILAND

Amani Corporation Ltd
 Phone: +66 2 322 44 21-3
 Fax: +66 2 322 67 05
 Email: amani@ksc.th.com

TURKEY

Sem Laboratuvar Cihazlari
 Phone: +90 216 571 02 00
 Fax: +90 216 571 02 02
 Email: info@sem.com.tr
 Web: www.sem.com.tr

UKRAINE

ITEX-LAB, LLC
 Phone: +380 48 728 87 48
 Fax: +380 48 760 18 67
 Email: Fittings@itexLLC.com.ua

UNITED ARAB EMIRATES

Technolab System
 Phone: +971 5045 03658
 Fax: +971 6749 8040
 Email: technols@eim.ae
 Web: technolabsys.com

UNITED KINGDOM

Thames Restek UK Limited
 Phone: +44 1494 564990
 Fax: +44 7816 912158
 Email: sales@thamesrestek.co.uk
 Web: www.thamesrestek.co.uk

USA

VICI Precision Sampling
 Phone: +1 225 927 1128
 Toll free +1 800 828 1653
 Fax: +1 225 923 1331
 Email: precscamp@vici.com
 Web: www.vici.com

ALL OTHER COUNTRIES

VICI AG International
 Phone: +41 41 925 62 00
 Fax: +41 41 925 62 01
 Email: info@vici.ch
 Web: www.vici.com
 www.vici-jour.com

NOTE

Our products could also be available from your local distributor. Please contact VICI AG International for other countries.

www.vici-jour.com



VICI Jour[®]

VICI AG International

Parkstrasse 2
6214 Schenkon
Switzerland

Phone +41 41 925 62 00

Fax +41 41 925 62 01

Email info@vici.ch

© 2018 by VICI AG International

Printed in Switzerland

This environment-friendly paper has been produced
using pulp bleached without chlorine.